

<p>A</p> <p>1PC</p>	<p>B</p> <p>1PC</p>	<p>C</p> <p>1PC</p>	<p>D</p> <p>1PC</p>	<p>E</p> <p>1PC</p>
<p>F</p> <p>1PC</p>	<p>G</p> <p>1PC</p>	<p>H</p> <p>M6x35MM 10 PCS</p>	<p>I</p> <p>M6x40MM 15 PCS</p>	<p>J</p> <p>M6x25MM 1 PC</p>
<p>K</p> <p>phi 16x1MM 26 PCS</p>	<p>L</p> <p>4x4MM 1PC</p>	<p>M</p> <p>1PC</p>		

1

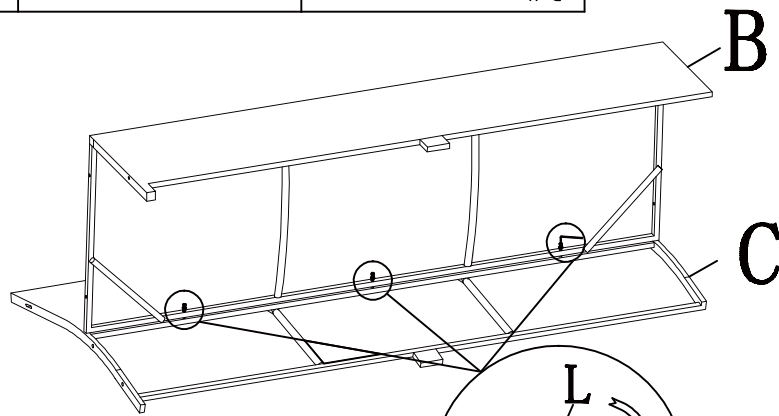

2

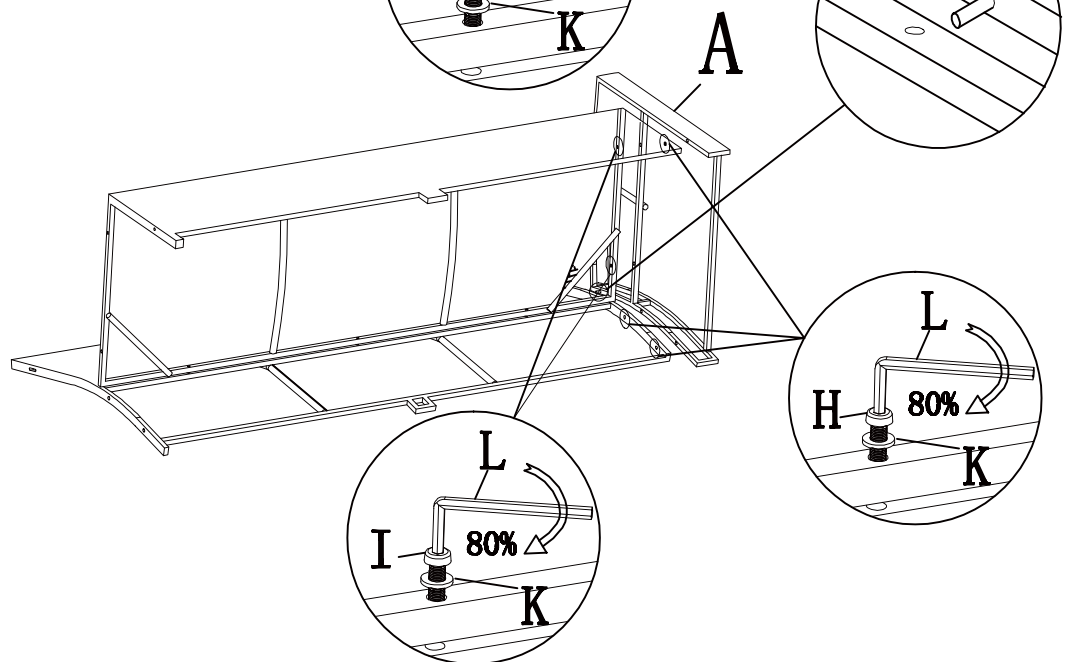

3

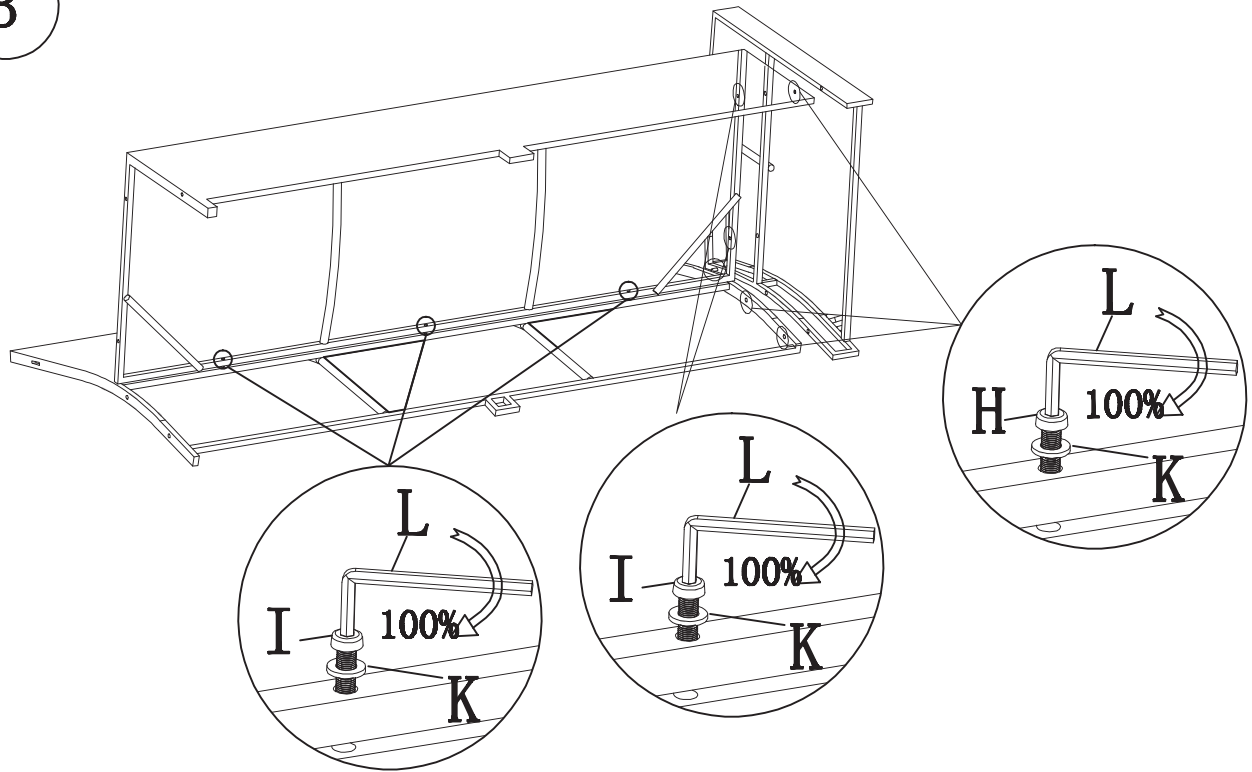

4

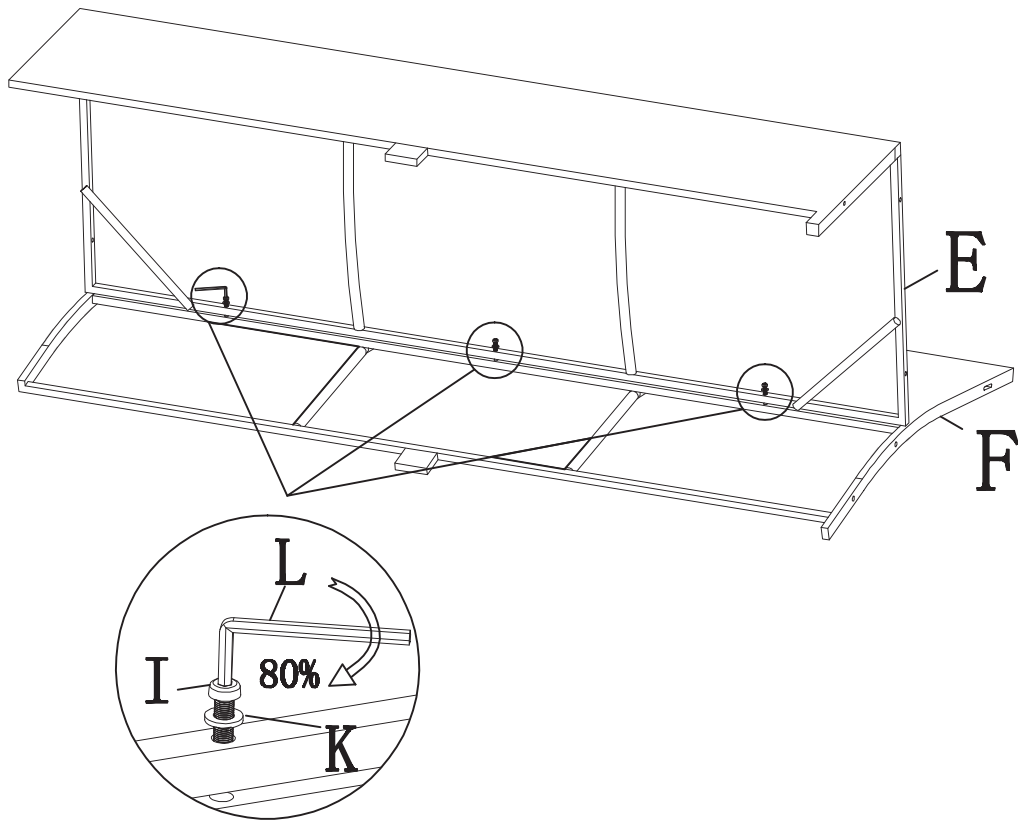

5

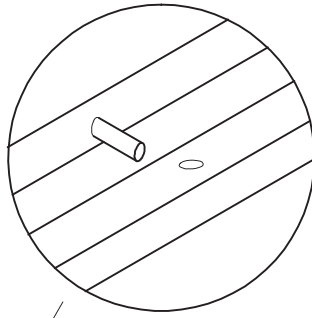

D

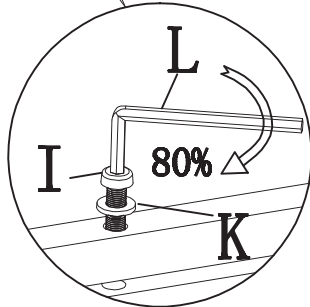
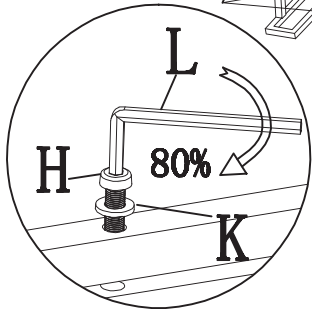
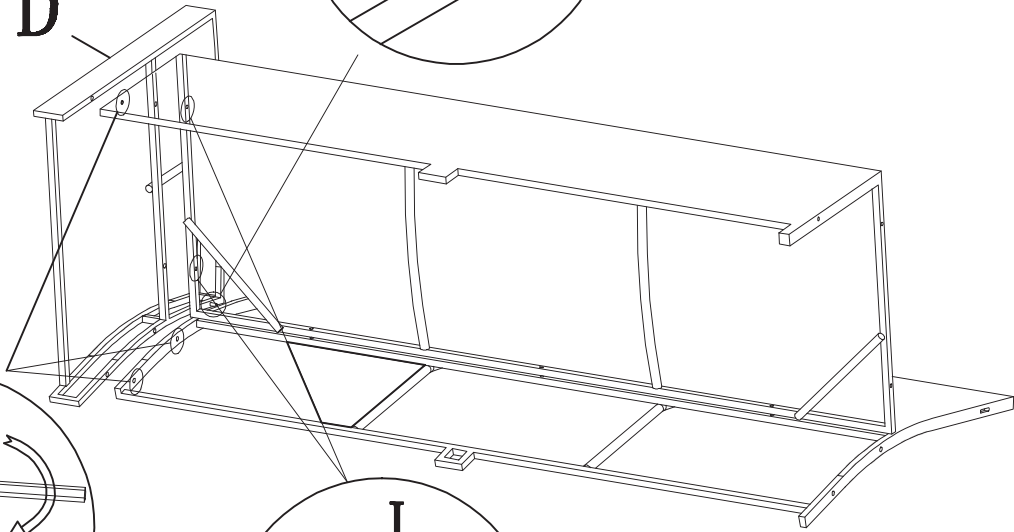

6

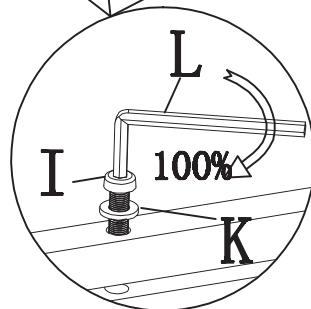
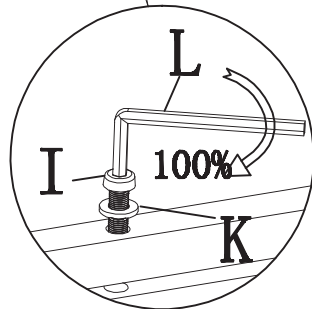
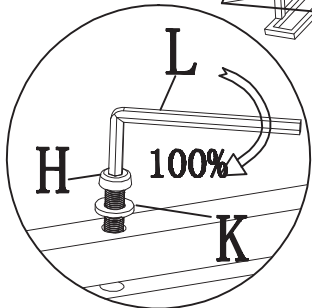
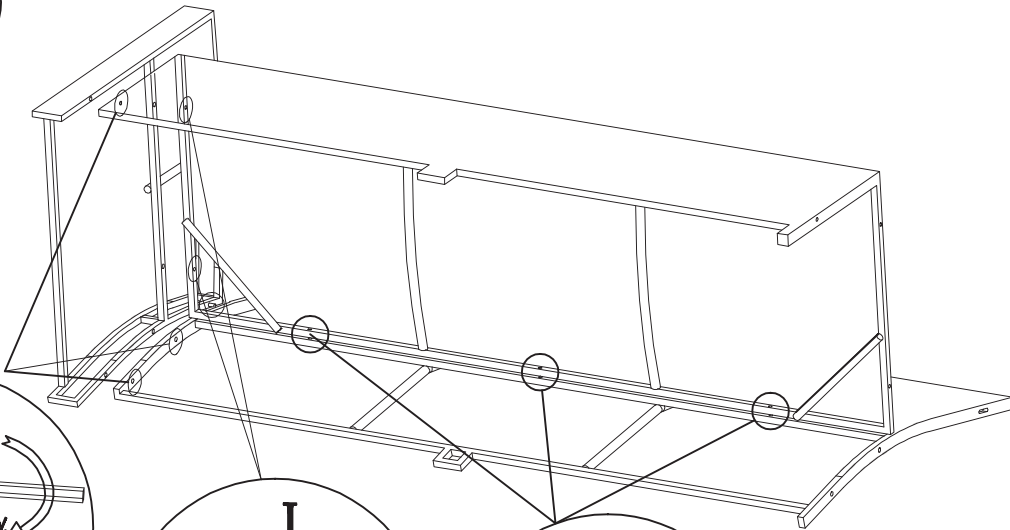

7

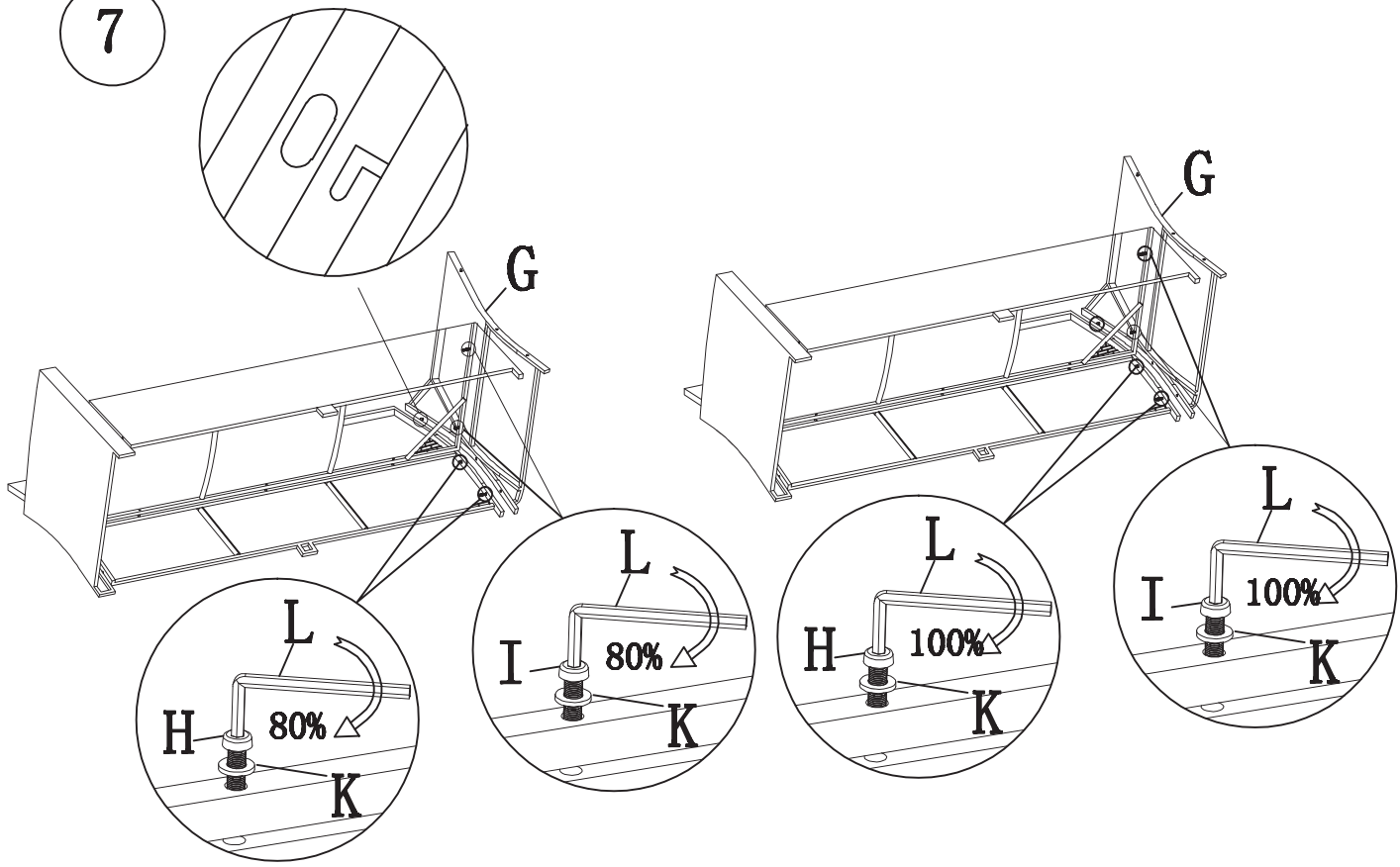

8

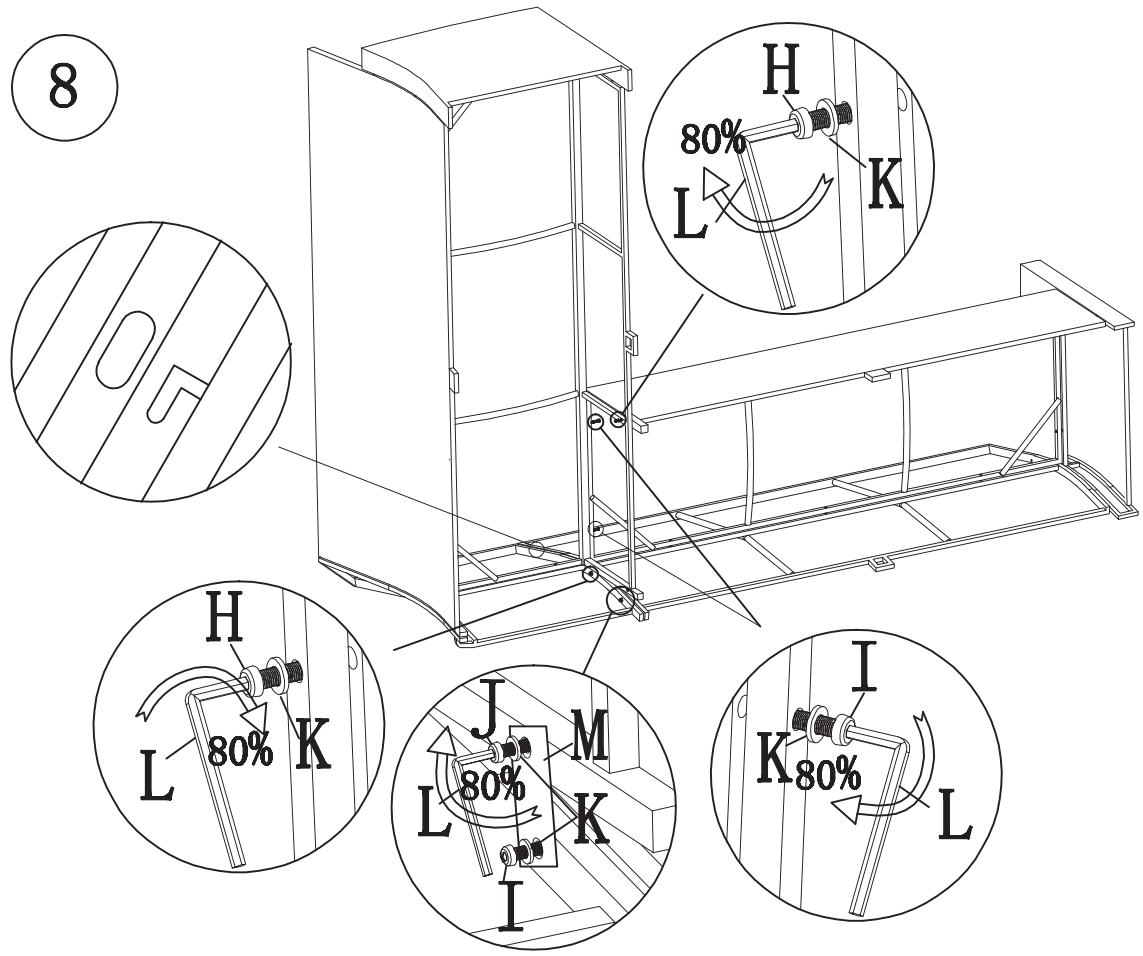

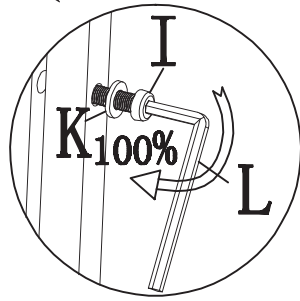
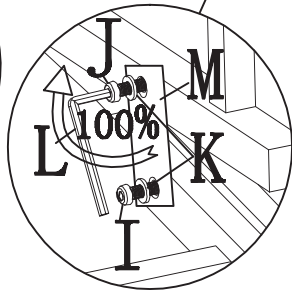
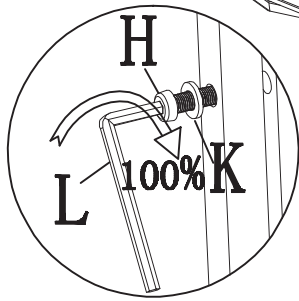
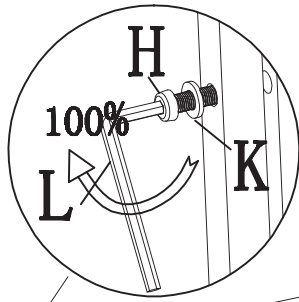
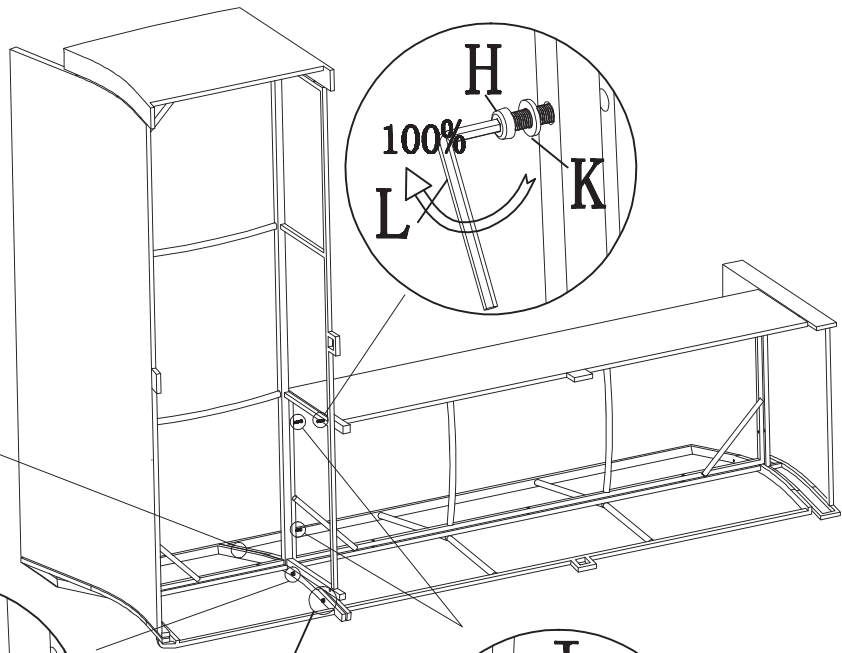
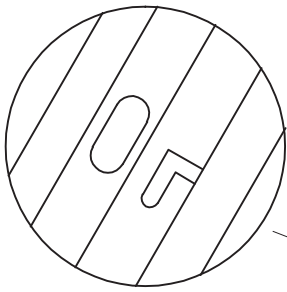

9

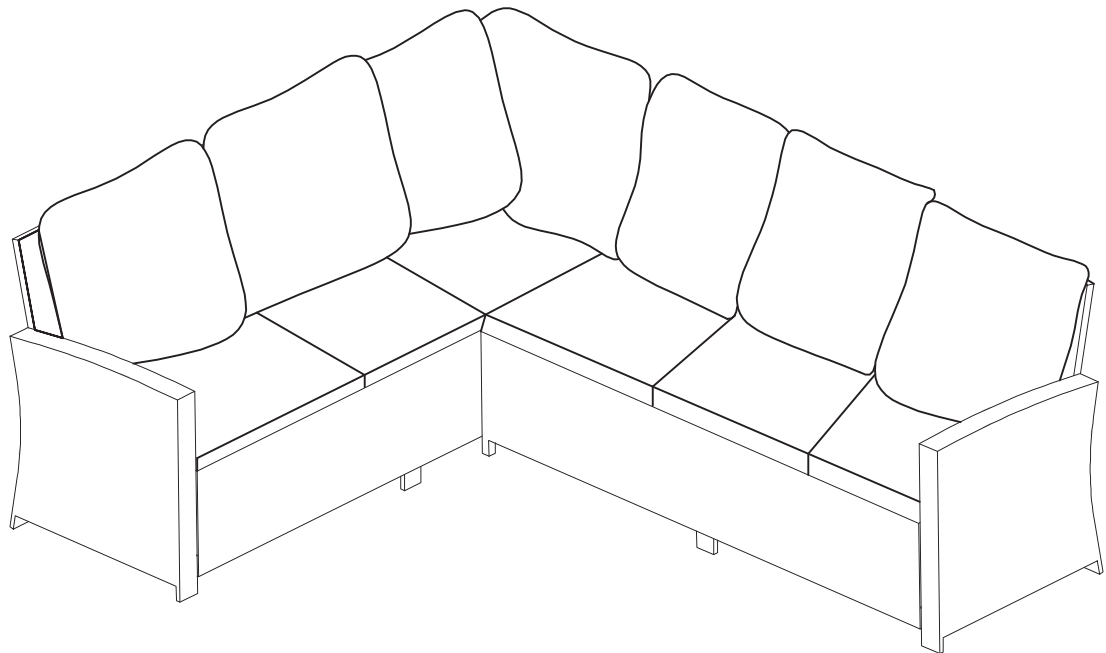

10

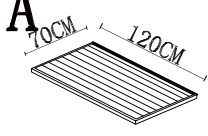
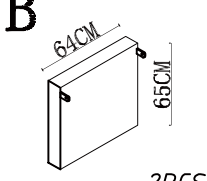
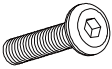
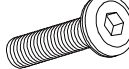

A  1PC	B  2PCS	C  M6x25MM 4 PCS	D  M6x35MM 4 PCS	E  Φ 16x1MM 8 PCS	F  4x4MM 1PC
--	---	--	---	---	--

1

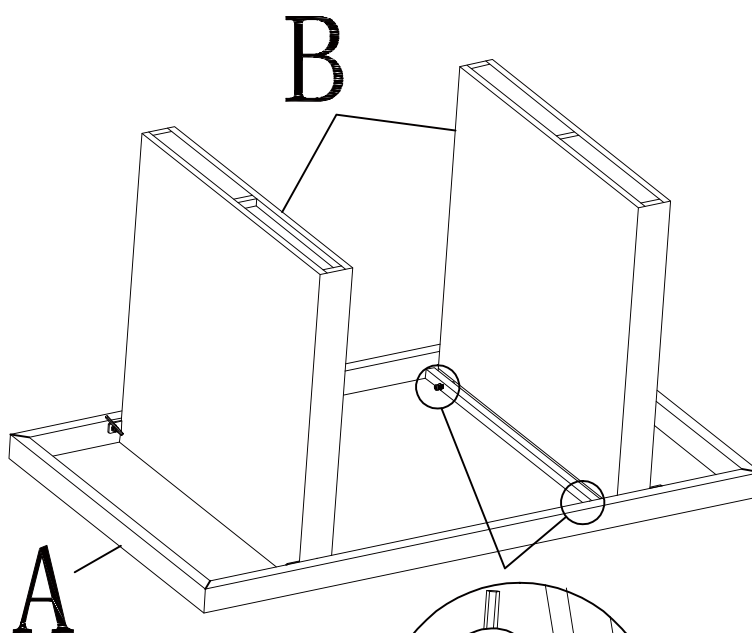

2

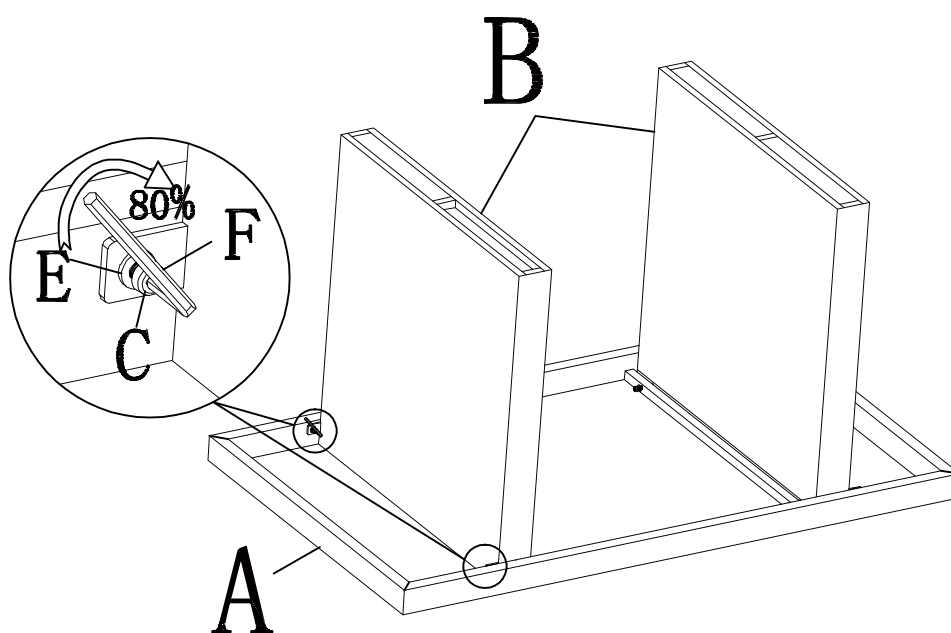

3

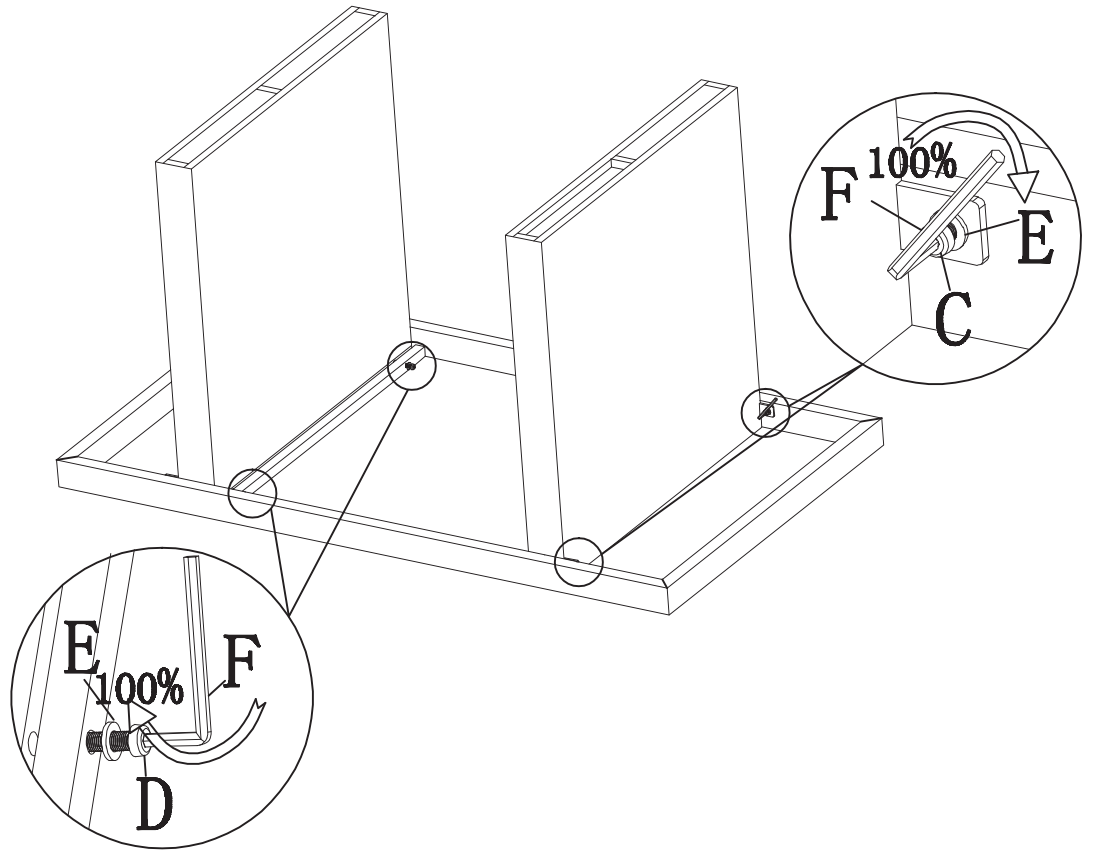

4

