

AUFBAUANLEITUNG

Mülltonnenbox „Alex“

- Ⓜ GB Assembly manual for dustbin box Alex
- Ⓜ FR Notice de montage pour range poubelles Alex
- Ⓜ NL Opbouwbeschrijving modulaire containerbox Alex
- Ⓜ ES Instrucciones de montaje para el contenedor de basura Alex
- Ⓜ IT Istruzioni di montaggio copribidone modulare Alex
- Ⓜ DK Monteringsvejledning skjul til affaldsbeholder Alex

For further languages please go to: www.biohort.com/downloads



WICHTIGE PUNKTE FÜR DEN AUFBAU!



VORLIEGENDE AUFBAUANLEITUNG ZEIGT DEN ZUSAMMENBAU VON DER MÜLLTONNENBOX „ALEX“. FÜR EINIGE MONTAGESCHRITTE BENÖTIGEN SIE EINEN HELFER.

- GB** Important details regarding assembly! The present assembly manual shows the erection of the dustbin box "Alex". For several assembly steps additional assistance of 1 people will be required.
- FR** Points importants lors du montage! Cette notice de montage décrit l'assemblage du Range poubelles « Alex ». Pour certaines étapes, demandez l'aide d'une personnes.
- NL** Deze opbouwbeschrijving toont de montage van de ContainerBox „Alex“. Voor enkele montage stappen heeft u 1 extra mensen nodig.
- ES** Notas importantes para el montaje: Estas instrucciones de montaje muestran cómo montar el contenedor de basura „Alex“. Es recomendable realizar el montaje entre dos personas.
- IT** Indicazioni importanti per il montaggio! Il presente manuale mostra come assemblare di cassonetto per i bidoni della spazzatura „Alex“. Per alcune fasi di assemblaggio vi serviranno 1 aiutanti.
- DK** Den medsendte montagevejledning viser samlingen af skjul til affaldsbeholder "Alex". Ved flere punkter af opsætningen er yderligere hjælp påkrævet af 1 personer.

BENÜTZEN SIE BEI DER MONTAGE ARBEITSHANDSCHUHE! UM KRATZER ZU VERMEIDEN, VERWENDEN SIE BITTE GEEIGNETE UNTERLAGEN!



- GB** Wear working gloves! Please use a suitable underlay to avoid scratches!
- FR** Portez des gants de travail! Pour éviter les rayures, utilisez les supports appropriés!
- NL** Handschoenen gebruiken! Om krassen te voorkomen raden wij u aan er iets onder te leggen!
- ES** Utilice unos guantes de trabajo. Por favor, coloque en el suelo una base protectora adecuada para evitar posibles arañazos.
- IT** Utilizzare guanti da lavoro. Utilizzare una base adatta per evitare graffi!
- DK** Brug arbejdshandsker! Benyt venligst et passende underlag for at undgå skrammer!

UMGANG MIT BESCHÄDIGTEN TEILEN

Verbauen Sie keine beschädigten Teile! Falls Sie Beschädigungen feststellen, müssen diese vorab inkl. aussagekräftiger Bilder an uns gemeldet werden. Durch den Verbau gelten die Teile als akzeptiert.

- GB** Handling of damaged parts: Do not install damaged parts! If you note damages, they must be reported to us in advance, including meaningful pictures. The parts are considered accepted by the installation.
- FR** Manipulation des pièces endommagées: N'installez pas de pièces endommagées ! Si vous découvrez des dommages, vous devez nous en informer à l'avance, en nous envoyant des photos significatives. Après le montage, les pièces sont considérées comme acceptées.
- NL** Omgaan met beschadigde onderdelen: Monteer géén beschadigde onderdelen! Als u schade ontdekt, moet dit vooraf aan ons worden gemeld, inclusief duidelijke foto's. Als u de beschadigde onderdelen toch monteert, dan heeft u hiermee het product "geaccepteerd".
- ES** Manejo de partes dañadas: Por favor, NO instale partes dañadas, Si descubre algún daño, debe informarnos con antelación, incluyendo fotos claras de los daños. Las piezas se consideran aceptadas si se realiza su la instalación.
- IT** Gestione di parti danneggiate: Non installare parti danneggiate! Se si rivela un danno, questo deve essere segnalato in anticipo per mail con materiale fotografico a supporto del reclamo. Se si procede all'installazione delle parti danneggiate, Biohort si riserva il diritto di respingere il reclamo.
- DK** Håndtering af beskadigede dele: Brug ikke beskadigede dele! Hvis du opdager nogen skade, skal dette rapporteres til os på forhånd, herunder meningsfulde billeder. Dele betragtes som accepteret gennem installationen.

SCHRAUBVERBINDUNGEN GRUNDSÄTZLICH ERST AM ENDE DER MONTAGE FESTZIEHEN!

- GB** Nuts not to be tightened before the end of assembly!
- FR** Ne serrer les écrous à fond qu'à la fin du montage!
- NL** Schroeven pas aan het einde van de montage vastdraaien!
- ES** En principio, no apriete fijamente las tuercas hasta que no haya terminado de montar la caseta.
- IT** I dadi devono essere serrati a fondo soltanto alla fine del montaggio!
- DK** Møtrikkerne må ikke strammes før slutningen af opsætningen!

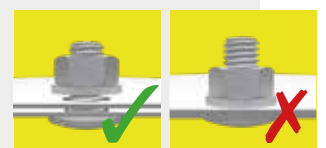

ACHTEN SIE AUF EINE STURMSICHERE BODENVERANKERUNG UND VERRIEGELN SIE DIE TÜREN! NICHT BEI WIND AUFBAUEN!



- (GB) Please make sure the product is anchored in a storm-proof manner and lock the doors! Do not assembly in windy condition!
- (FR) Veillez à ce que le sol soit ancré de manière à résister aux tempêtes et verrouillez les portes! Ne pas procéder au montage dans des conditions venteuses!
- (NL) Zorg voor een stormbestendige bodem verankering en vergrendel de deuren! Niet opbouwen in winderige omstandigheden!
- (ES) Asegúrese de que el suelo cuente con un anclaje a prueba de tormentas y cierre las puertas. ¡No se instalen en condiciones de viento!
- (IT) Assicuratevi che il pavimento sia ancorato a prova di tempesta e chiudete a chiave le porte! Non montare in condizioni di vento!
- (DK) Vær opmærksom på at produktet forankres stormsikkert samt at dør er aflåst! Bør ikke monteres ved kraftig vind!

HALTEN SIE WÄHREND DES ZUSAMMENBAUS ALLE MITGELIEFERTEN KLEINTEILE ODER VERPACKUNGSMATERIALIEN VON KLEINKINDERN FERN. Bauteile weisen scharfe Kanten auf oder stehen vor, achten Sie während der Montage und bei der täglichen Nutzung darauf.

- (GB) Keep all supplied small parts or packaging materials away from little children during assembly. Components have sharp edges or protrude, pay attention to them during assembly and during daily use.
- (FR) Gardez toutes les petites pièces ou les matériaux d'emballage fournis hors de portée des enfants pendant le montage. Les pièces d'assemblage peuvent être tranchantes, faites-y attention lors de l'assemblage et de l'utilisation quotidienne.
- (NL) Houd alle kleine onderdelen of verpakkingsmaterialen die worden mee geleverd uit de buurt van kleine kinderen tijdens de montage. Onderdelen hebben scherpe randen of steken uit, let op bij de montage en bij het dagelijks gebruik.
- (ES) Mantenga todas las piezas pequeñas o materiales de embalaje suministrados lejos de los niños durante el montaje. Los componentes tienen bordes afilados o salientes, preste atención a ellos durante el montaje y durante el uso diario.
- (IT) Tenere tutte le piccole parti o i materiali d'imballaggio forniti lontano dalla portata dei bambini durante il montaggio. I componenti hanno spigoli vivi o sporgenti, prestare attenzione ad essi durante il montaggio e durante l'uso quotidiano.
- (DK) Hold alle leverede smådele og emballage utilgængeligt for børn under montagen. Komponenter har skarpe kanter eller stikker ud, vær opmærksom på dem under montering og under daglig brug.

ACHTUNG: IM SOMMER KÖNNEN IM INNENRAUM SEHR HOHE TEMPERATUREN ENTSTEHEN!



- (GB) Attention: In the summer, the inside can reach very high temperatures!
- (FR) Attention: En été la température à l'intérieur de l'abri peut être élevée!
- (NL) Let op: in de zomer kunnen in de berging zeer hoge temperaturen bereikt worden.
- (ES) Tenga en cuenta que en el verano las temperaturas en el interior pueden ser altas.
- (IT) Attenzione: Si prega di prendere nota che in estate si possono essere temperature molto elevate all'interno.
- (DK) Vigtigt: Der kan opstå meget høje temperaturer i skuret om sommeren.

PFLEGE UND WARTUNG

Keine aggressiven Chemikalien wie z.B. Chlor oder Streusalz lagern! Sonnenmilch und andere Cremen mit Wasser und Seife entfernen! Keine scheuernden Reinigungsmittel verwenden! Ölen Sie das Schloss jährlich!

- (GB) Care and maintenance: Do not store aggressive substances i.e. chlorine or road salt! Remove suntan lotion or any other creams with water and rinse aid! Do not use abrasive cleaning agents! Lubricate the lock once a year!
- (FR) Entretien et maintenance: Ne pas stocker de produits chimiques (chlore, sel, etc...) Nettoyez uniquement avec de l'eau les crèmes solaires et autres crèmes (pas de nettoyeur chimique). Graissez la serrure et les charnières chaque année!
- (NL) Onderhoud: Geen chemicaliën in de berging opslaan! Zonnebrandolie/melk en andere cremes met water en zeep verwijderen! Gebruik geen schuurmiddelen! Slot jaarlijks oliën
- (ES) Cuidado y mantenimiento: No almacene productos químicos agresivos dentro de la caseta como por ejemplo cloro y sal antiescarcha. Evite dejar huellas o restos de cremas solares sobre la chapa. Limpie la caseta siempre con agua o un trapo húmedo. Aplique aceite en la cerradura y las bisagras una vez al año
- (IT) Manutenzione: Non lasciare prodotti chimici aggressivi (come ad esempio cloro o sale per strade) all'interno della casetta! Rimuovere crema solare e altre creme con acqua e brillantante! Non utilizzare detergenti contenenti sostanze aggressive! Lubrificare la serratura e le cerniere a cadenza annuale!
- (DK) Pleje og vedligeholdelse: Opbevar ikke aggressive stoffer dvs. Klor eller vejsalt! Fjern solcreme eller andre typer af creme med vand og rensningsmiddel! Brug ikke aggressive rengøringsmidler! Smør låsen årligt!

ZUM SORTIEREN DER MITGELIEFERTEN SCHRAUBEN UND KLEINTEILE FINDEN SIE IM KARTON EIN FALTBARES ORDNUNGSSYSTEM.

- (GB) For sorting the supplied screws and small parts, you will find a foldable organiser system in the box.
- (FR) Pour trier les vis et les petites pièces fournies, vous trouverez dans le colis un système d'organisation pliable.
- (NL) Open de rolluiken van de StoreMax met beide handen aan de greepplaat.
- (ES) Para clasificar los tornillos y las piezas pequeñas suministradas, encontrará en la caja un sistema organizador plegable.
- (IT) Per sistemare le viti e le piccole parti in dotazione, troverete un contenitore pieghevole nella scatola.
- (DK) For at sortere de medfølgende skruer og små dele, finder du et foldbart organisationssystem i kassen.



MASSTABSGETREUE ABBILDUNGEN DER ZU VERWENDENDEN SCHRAUBEN:

- (GB) Scale drawing 1:1 of the screws in use
- (FR) Reproduction selon l'échelle 1:1.
- (NL) Afbeelding : schaal 1:1 (ware grootte)
- (ES) Reproducción a escala 1:1 de los tornillos que se utilizan para el montaje.
- (IT) Immagine in scala delle viti da utilizzare!
- (DK) Skala tegning af skruer er 1:1

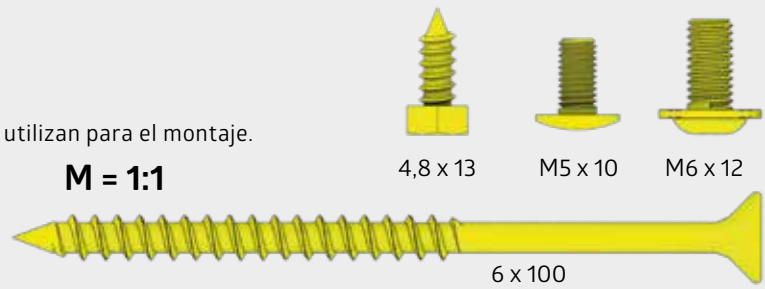

WASSERWAAGEN - SYMBOL: Betreffendes Einbauteil mit der Wasserwaage ausrichten.

- (GB) Symbol of spirit level: Align the respective parts by using the spirit level.
- (FR) Symbole niveau à bulle: Lorsque ce symbole apparaît, vous devez ajuster l'élément à l'aide d'un niveau à bulle.
- (NL) Waterpas – symbool: Bij montageschappen waar dit symbool bijstaat is het noodzakelijk het betreffende onderdeel waterpas in te bouwen.
- (ES) Símbolo del nivelador: Indica que se debe ajustar y centrar la pieza con la ayuda de un nivelador.
- (IT) Simbolo di livella a bolla d'aria: Allineare il componente in questione con l'ausilio di una livella a bolla d'aria.
- (DK) Symbol for vaterpas: Juster de respektive dele ved hjælp af vaterpas.

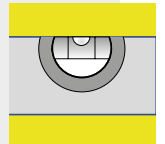

KEINE ABDECKUNG/HÜLLE FÜR DAS PRODUKT VERWENDEN!

- (GB) Do not use a cover for the product!
- (FR) Ne pas couvrir le produit, ne pas utiliser de housse.
- (NL) Gebruik geen afdekhoes voor het product!
- (ES) No utilice una cubierta/manga para el producto.
- (IT) Non utilizzare una copertura/manica per il prodotto!
- (DK) Produktet bør ikke tildækkes!

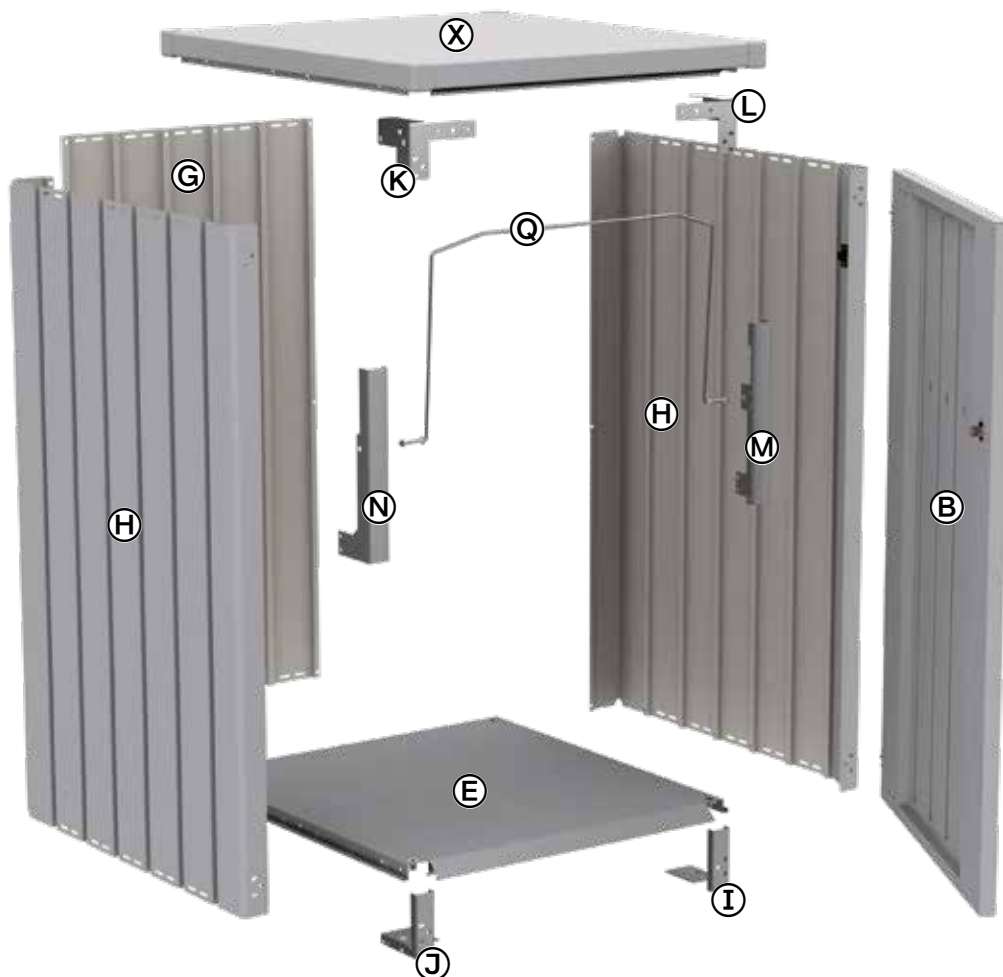

1 TÜR - DECKELPAKET



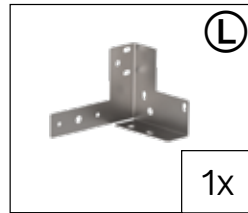
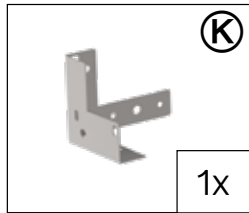
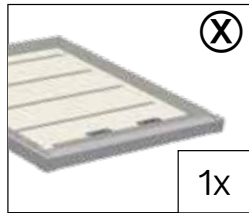
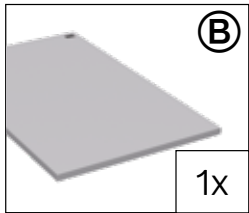

Door/lid package · Colis porte/couvercle · Deur/Dekselpaket · Puerta / Paquete de tapa · Pacchetto porta/coperchio · Dør/Låg pakke

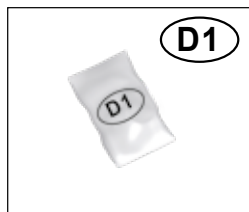
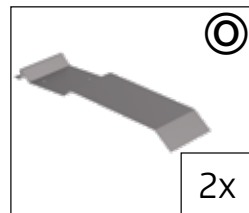
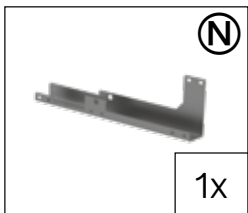
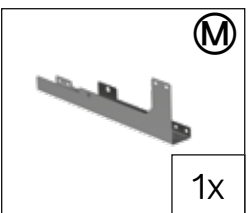
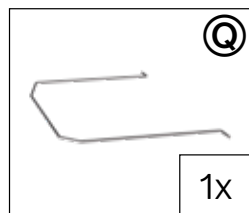
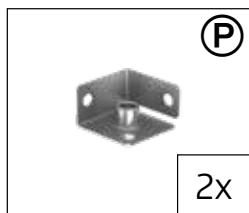
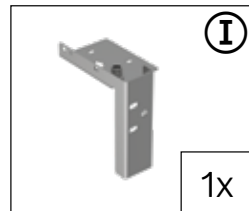
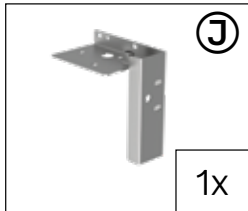
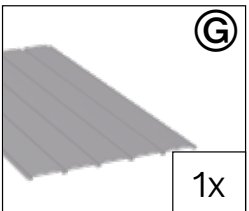
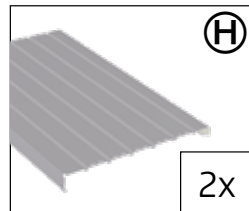
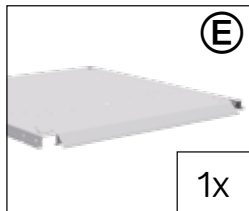

2 KORPUS - PAKET

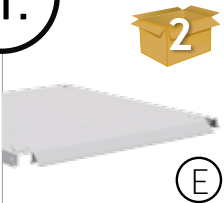
Corpus package · Colis de l'ossature · Framepakket · Corpus · Corpus · Kassepakke

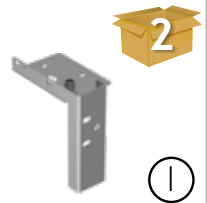
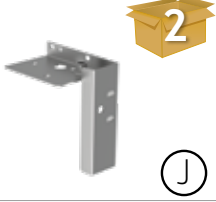

1.	 2 E	1x	 2 P	2x	 2 I	1x
	 2 J	1x	M5 x 10  2 D1	16x		

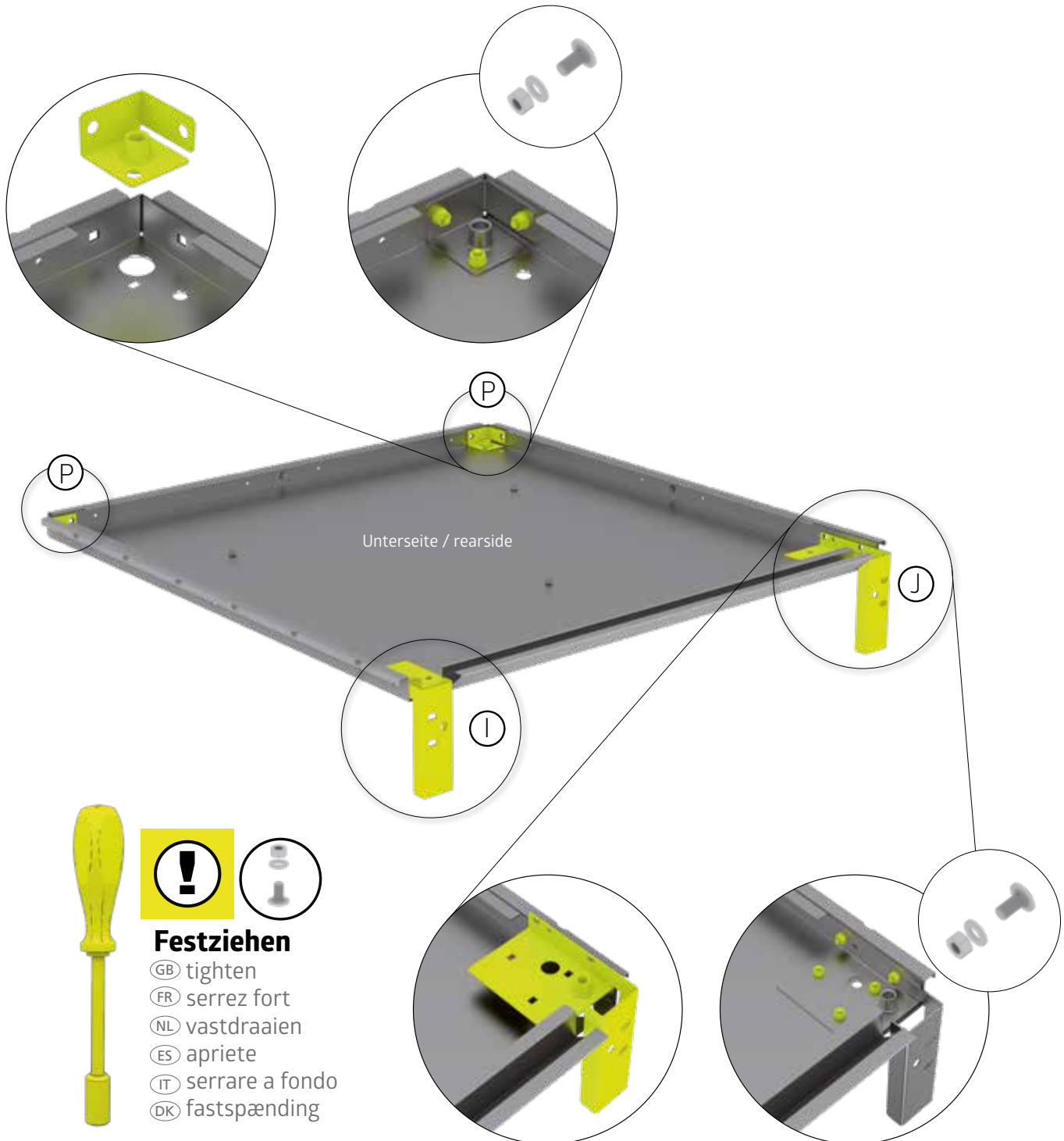

2.

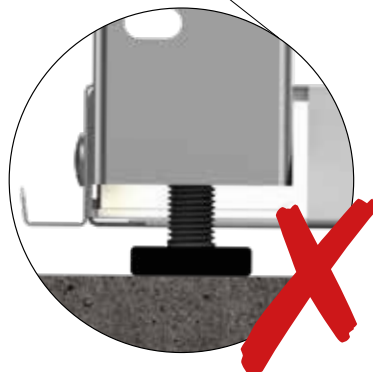
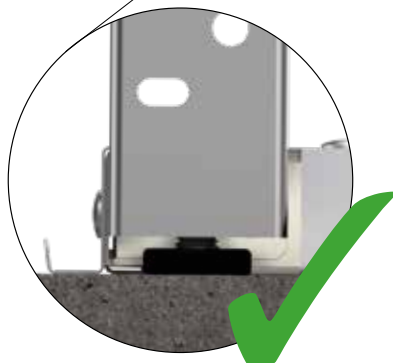
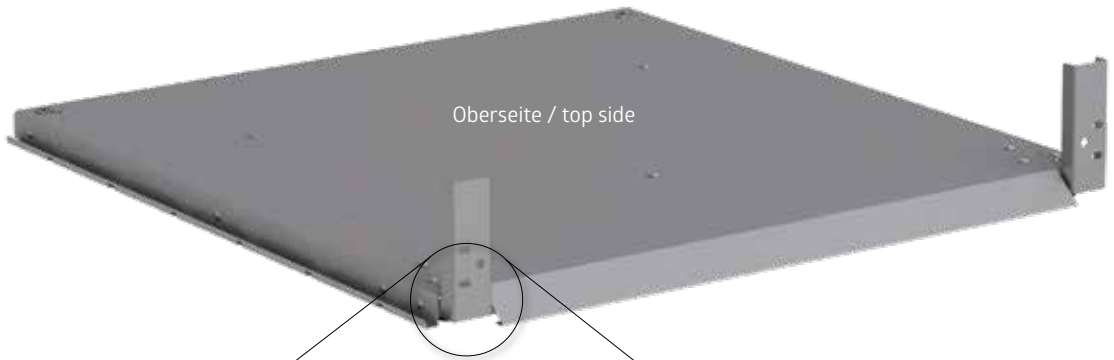
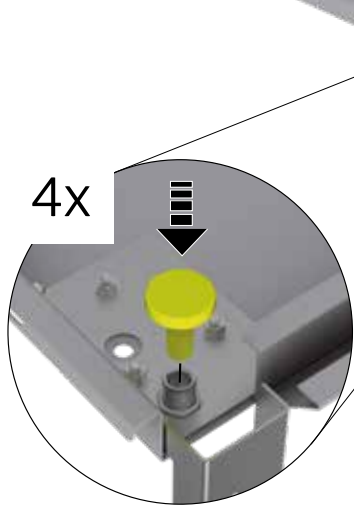
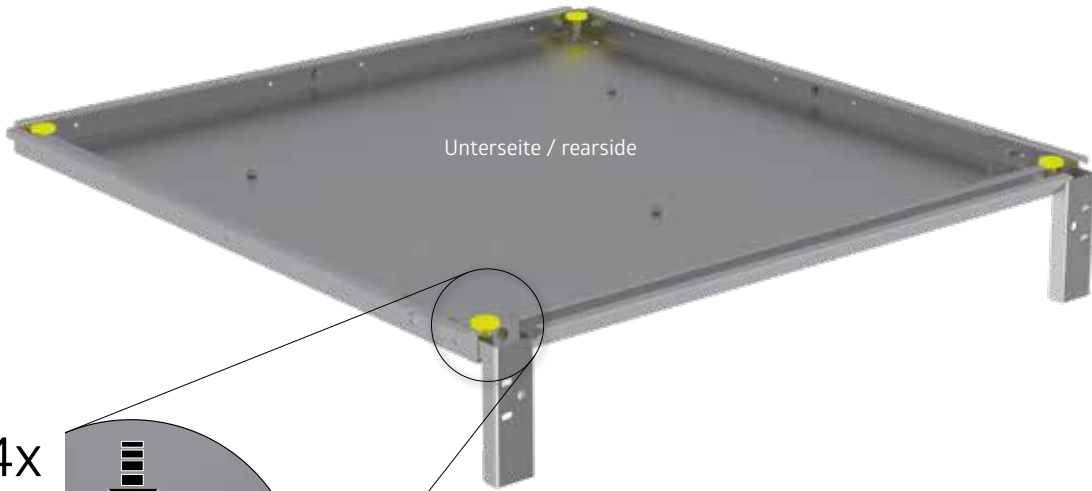

3.

	1x	4,8 x 13 	4x
---	----	--	----

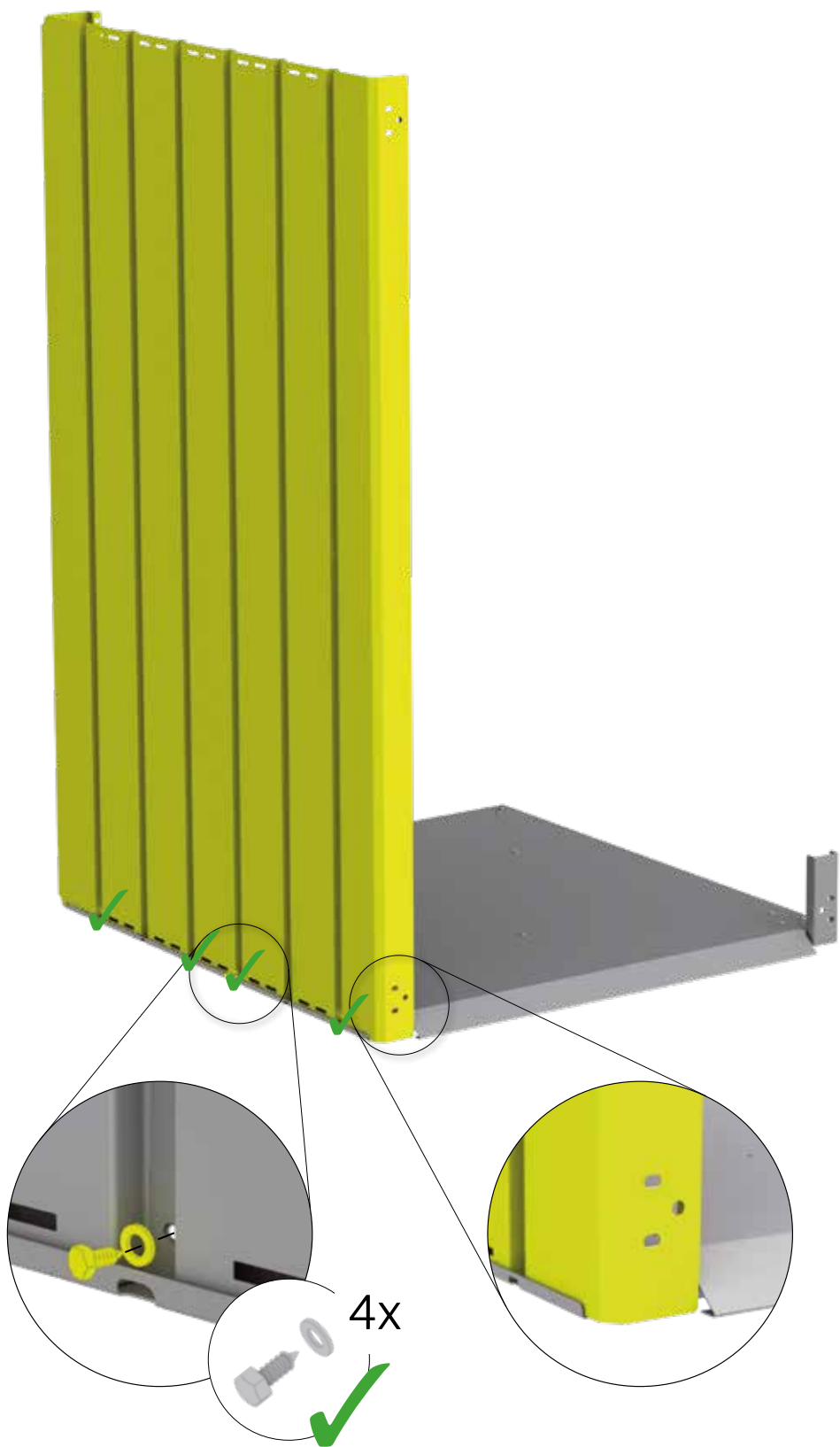

4.		1x		3x		1x
----	--	----	---	----	---	----

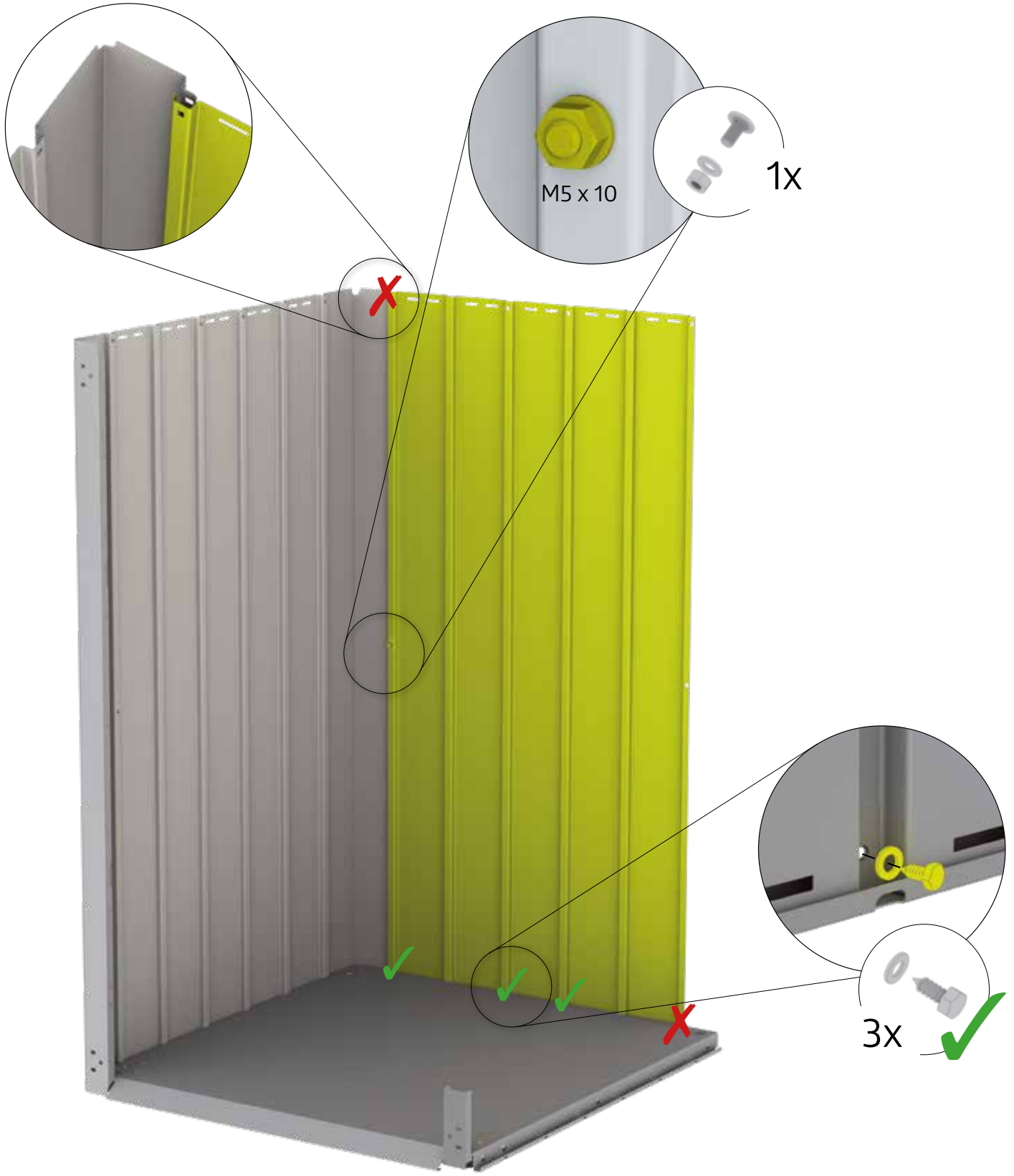

5.		1x	 4,8 x 13	5x	 M5 x 10	1x
----	--	----	---	----	--	----

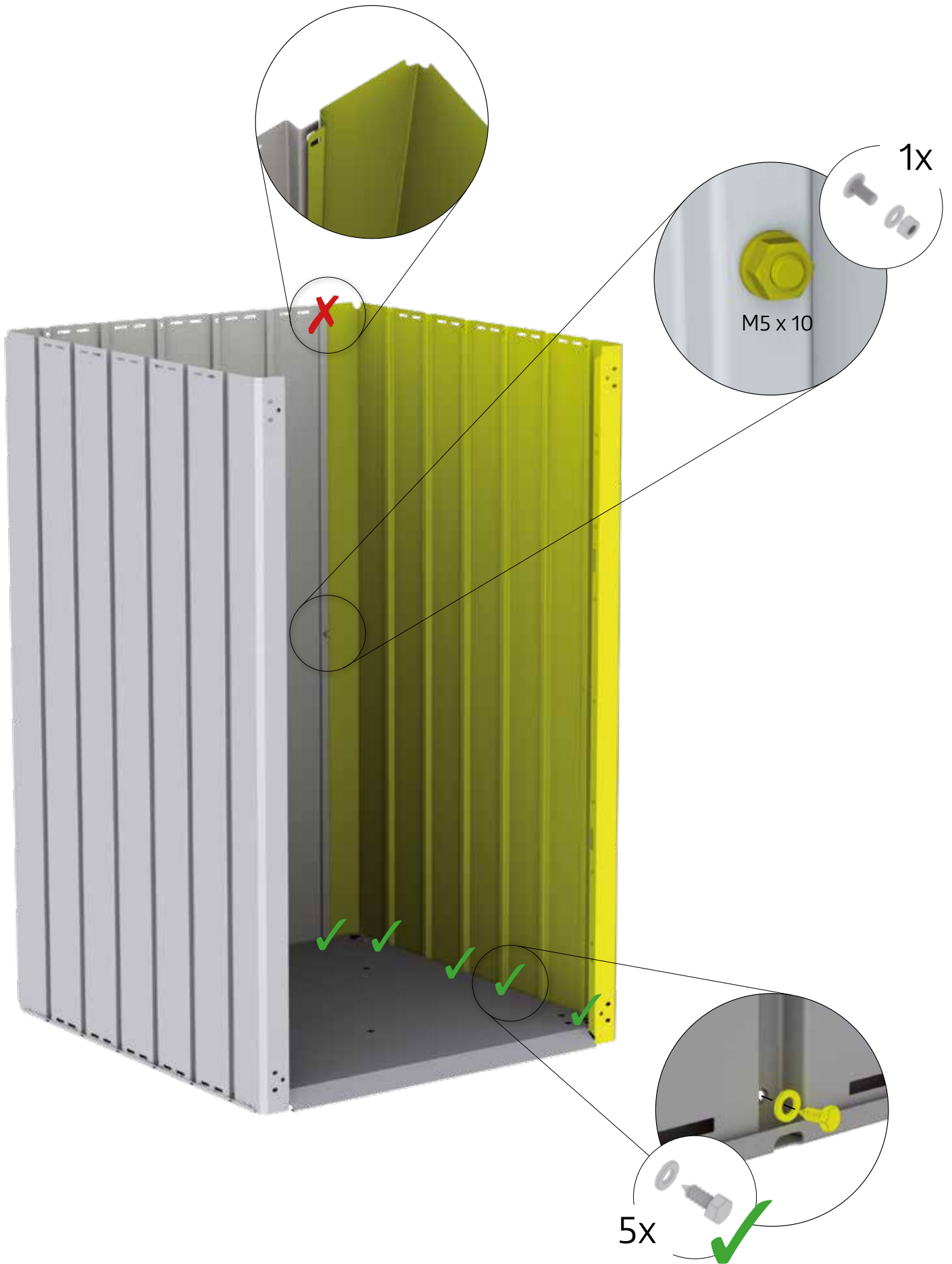

6.

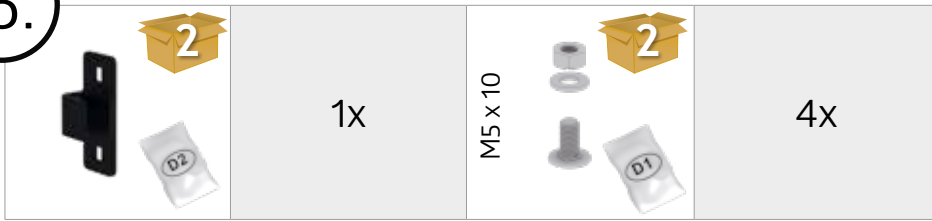

Festziehen

- Ⓒ^{GB} tighten
- Ⓒ^{FR} serrez fort
- Ⓒ^{NL} vastdraaien
- Ⓒ^{ES} apriete
- Ⓒ^{IT} serrare a fondo
- Ⓒ^{DK} fastspænding

2x

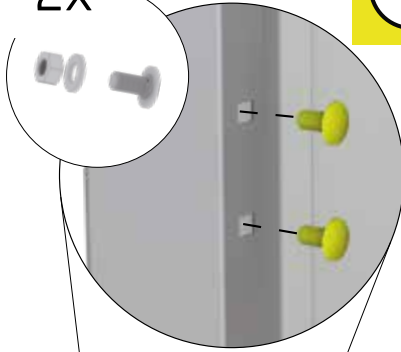

Schrauben dienen zur Abdeckung.

- Ⓒ^{GB} Screws are used for the covering.
- Ⓒ^{FR} Utilisez les vis pour le recouvrement.

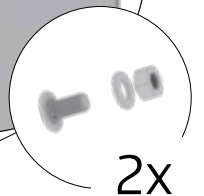
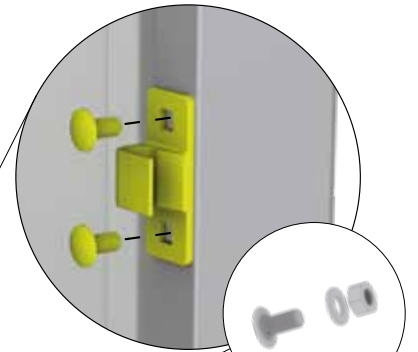

2x



Teil kann auch auf gegenüberliegender Seite montiert werden!

- Ⓒ^{GB} Part can be assembled on the opposite side.
- Ⓒ^{FR} La pièce peut également être montée sur le côté opposé.



7.

 2 N	1x	 2 M	1x	 2 Q	1x
 2 D2	4x	 2 D1	2x		

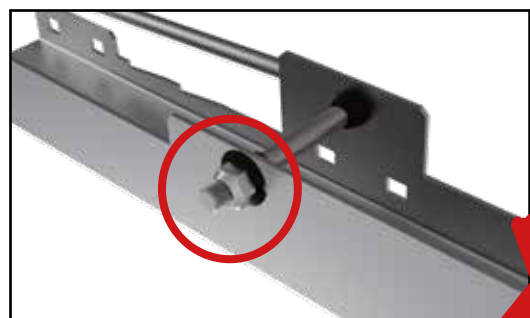
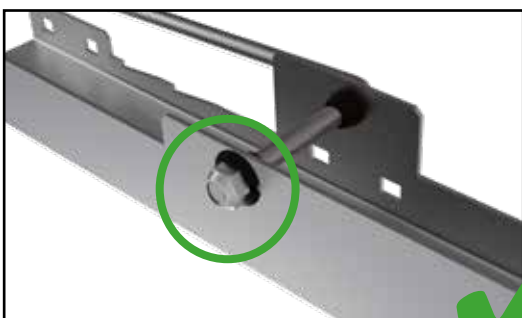
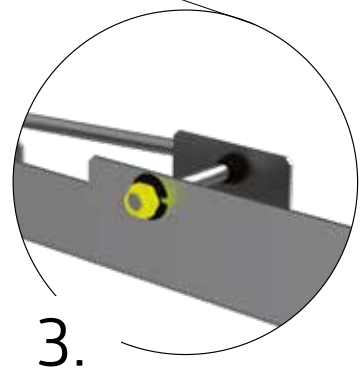
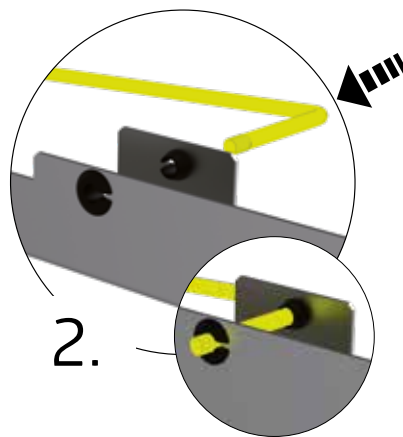
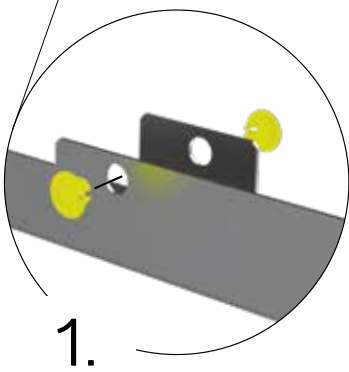
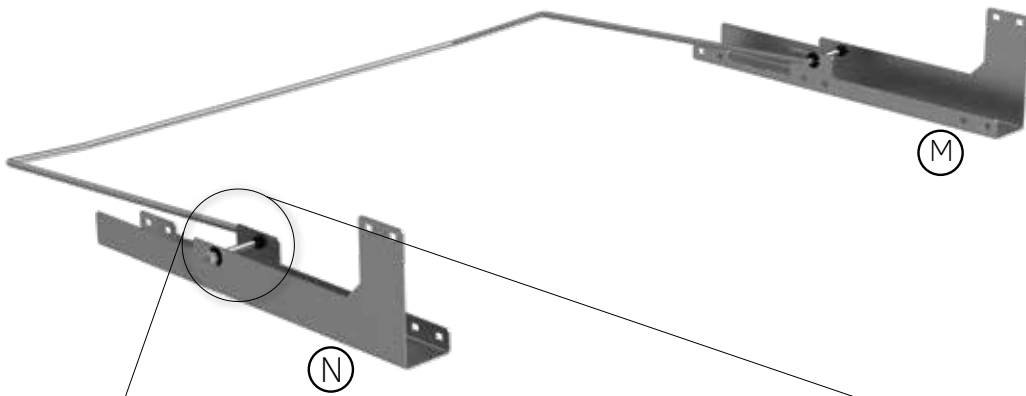
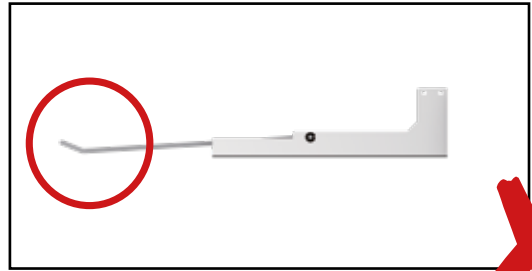
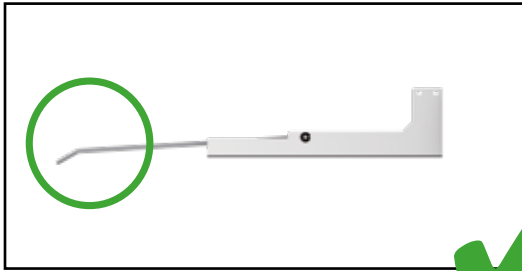

8.

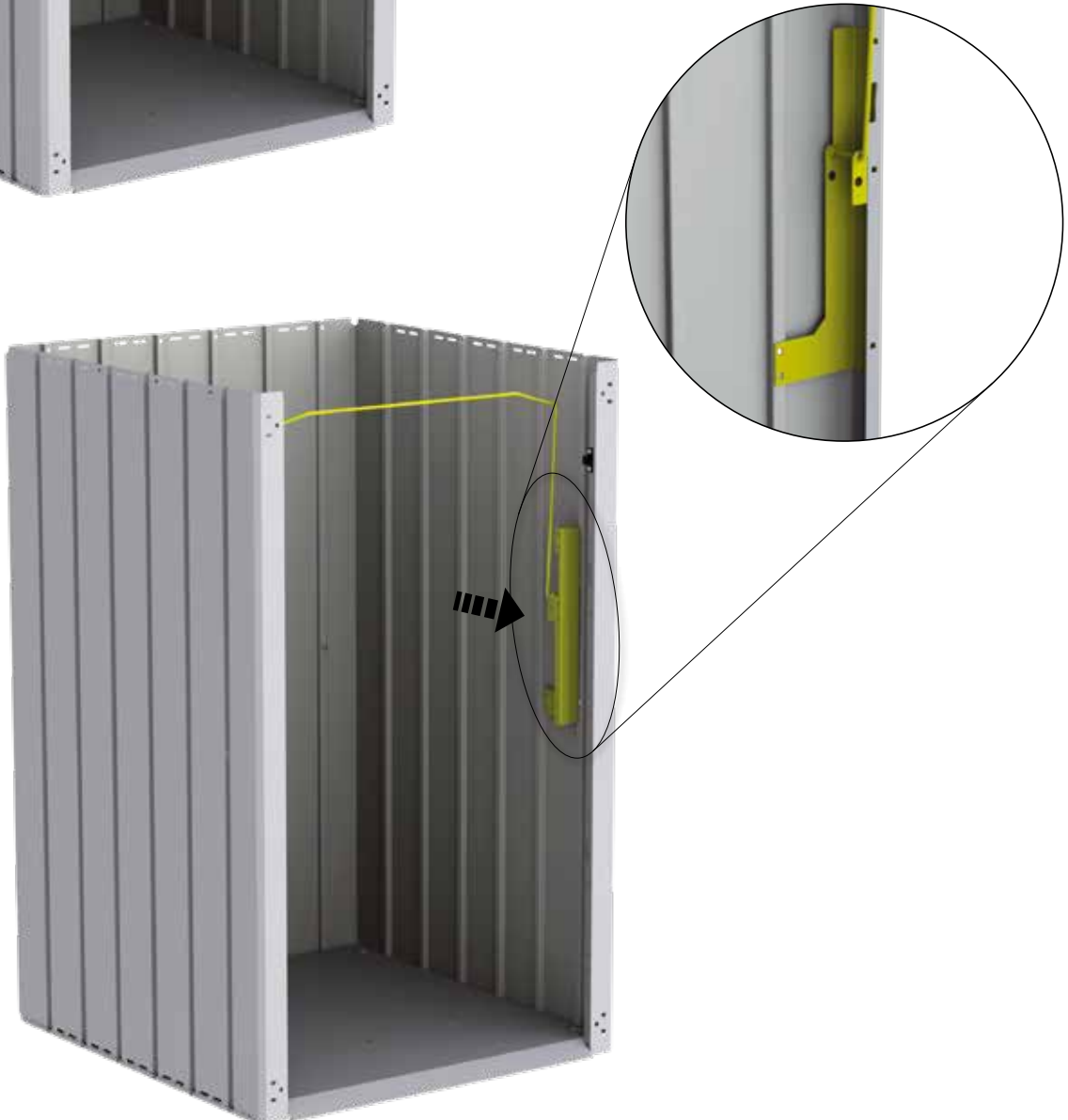
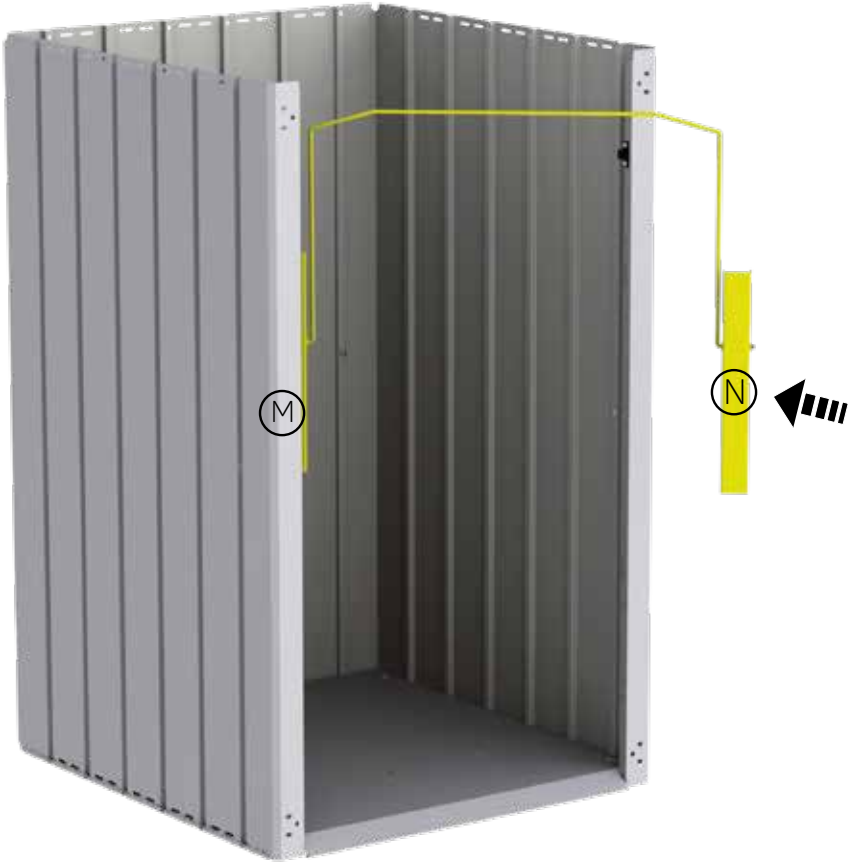

9.

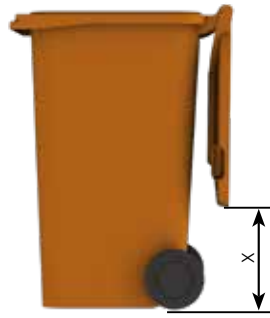

X	<350 mm	Option 1
X	>350 mm	Option 2



Option 1:



Option 2:

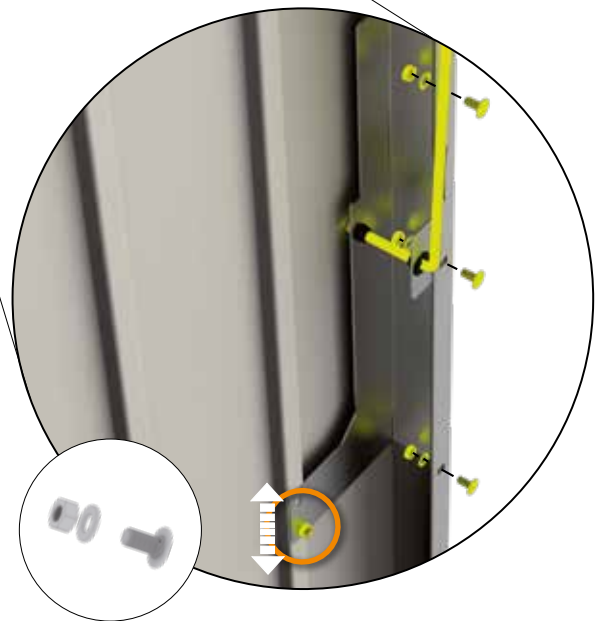

Festziehen

- (GB) tighten
- (FR) serrez fort
- (NL) vastdraaien
- (ES) apriete
- (IT) serrare a fondo
- (DK) fastspænding

10.

M5 x 10



8x



Schrauben dienen zur Abdeckung.

Ⓒ GB Screws are used for the covering.

Ⓒ FR Utilisez les vis pour le recouvrement.



Festziehen

Ⓒ GB tighten

Ⓒ FR serrez fort

Ⓒ NL vastdraaien

Ⓒ ES apriete

Ⓒ IT serrare a fondo

Ⓒ DK fastspænding

11. Deckelmontage - Lid assembly

	1x		1x		1x
	4x		4x		

Festziehen
 (GB) tighten
 (FR) serrez fort
 (NL) vastdraaien
 (ES) apriete
 (IT) serrare a fondo
 (DK) fastspænding

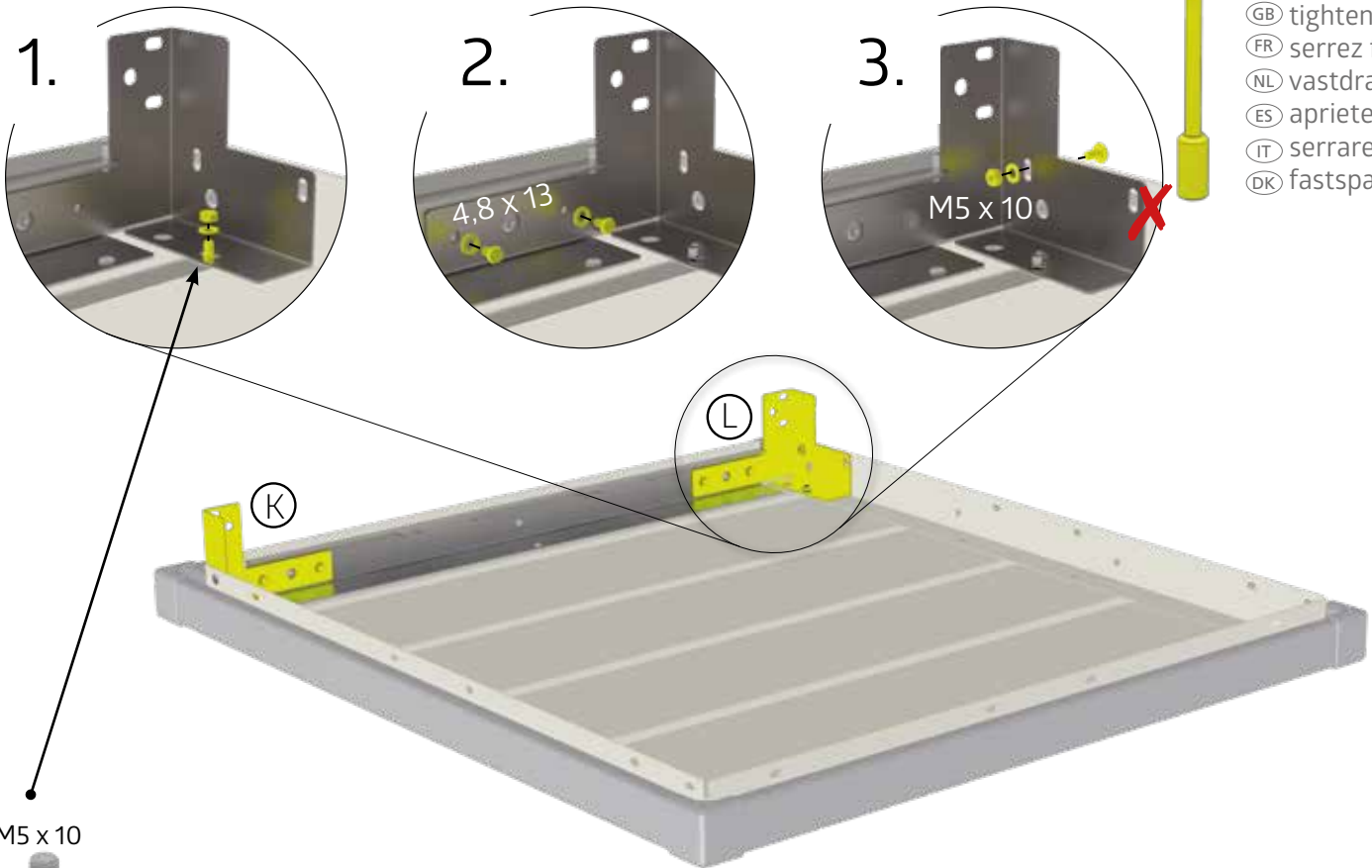

12. Deckelmontage - Lid assembly

 2	1x	 2	1x
--	----	--	----



Festziehen

- ⒸGB tighten
- ⒸFR serrez fort
- ⒸNL vastdraaien
- ⒸES apriete
- ⒸIT serrare a fondo
- ⒸDK fastspænding

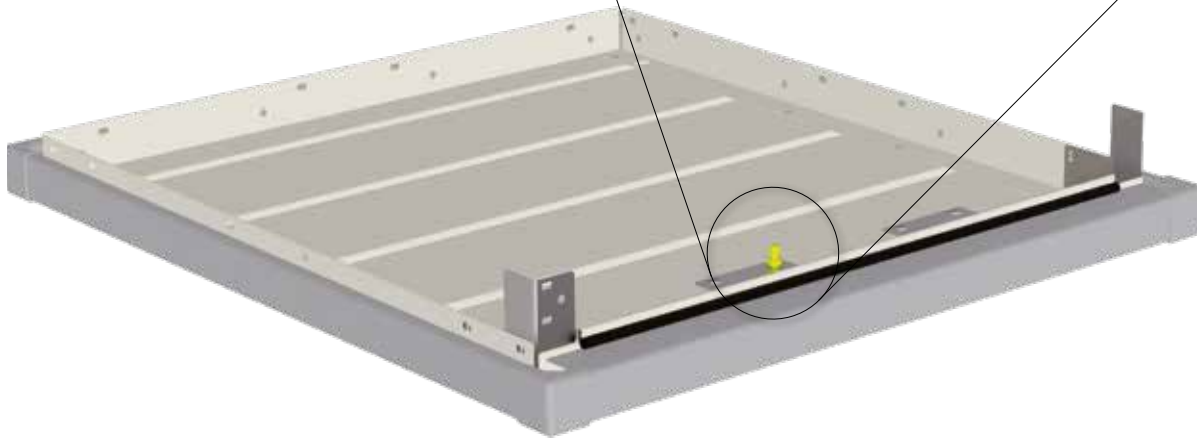
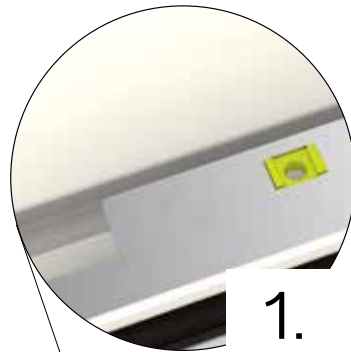

13. Deckelmontage - Lid assembly

M5 x 10



12x

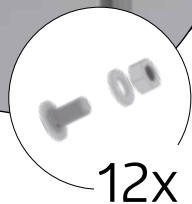
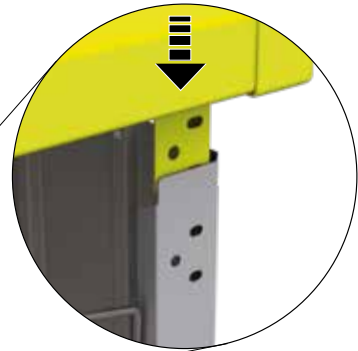

12x

14.

	1x		2x	M5 x 10		7x
--	----	--	----	---------	--	----

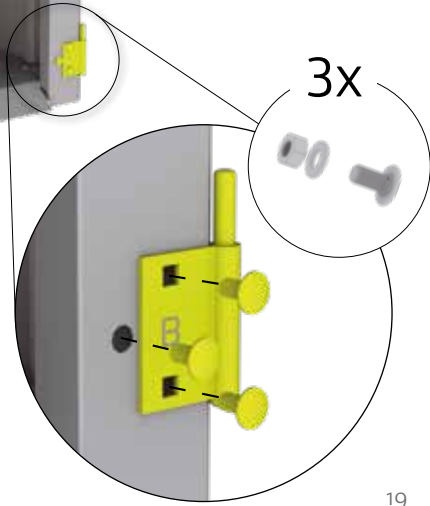
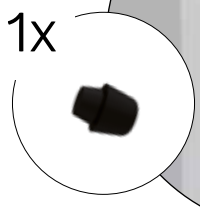
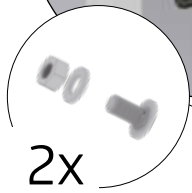
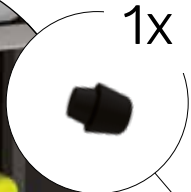
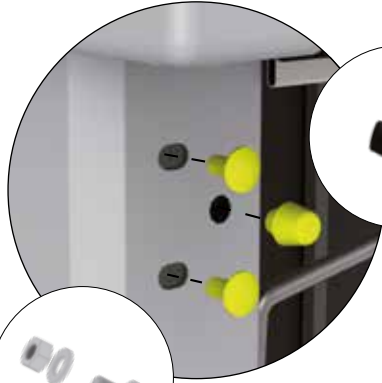

15.

	1x		1x		1x
	1x		1x		4x



Festziehen

- Ⓒ tighten
- Ⓕ serrez fort
- Ⓖ vastdraaien
- Ⓔ apriete
- Ⓘ serrare a fondo
- Ⓙ fastspænding

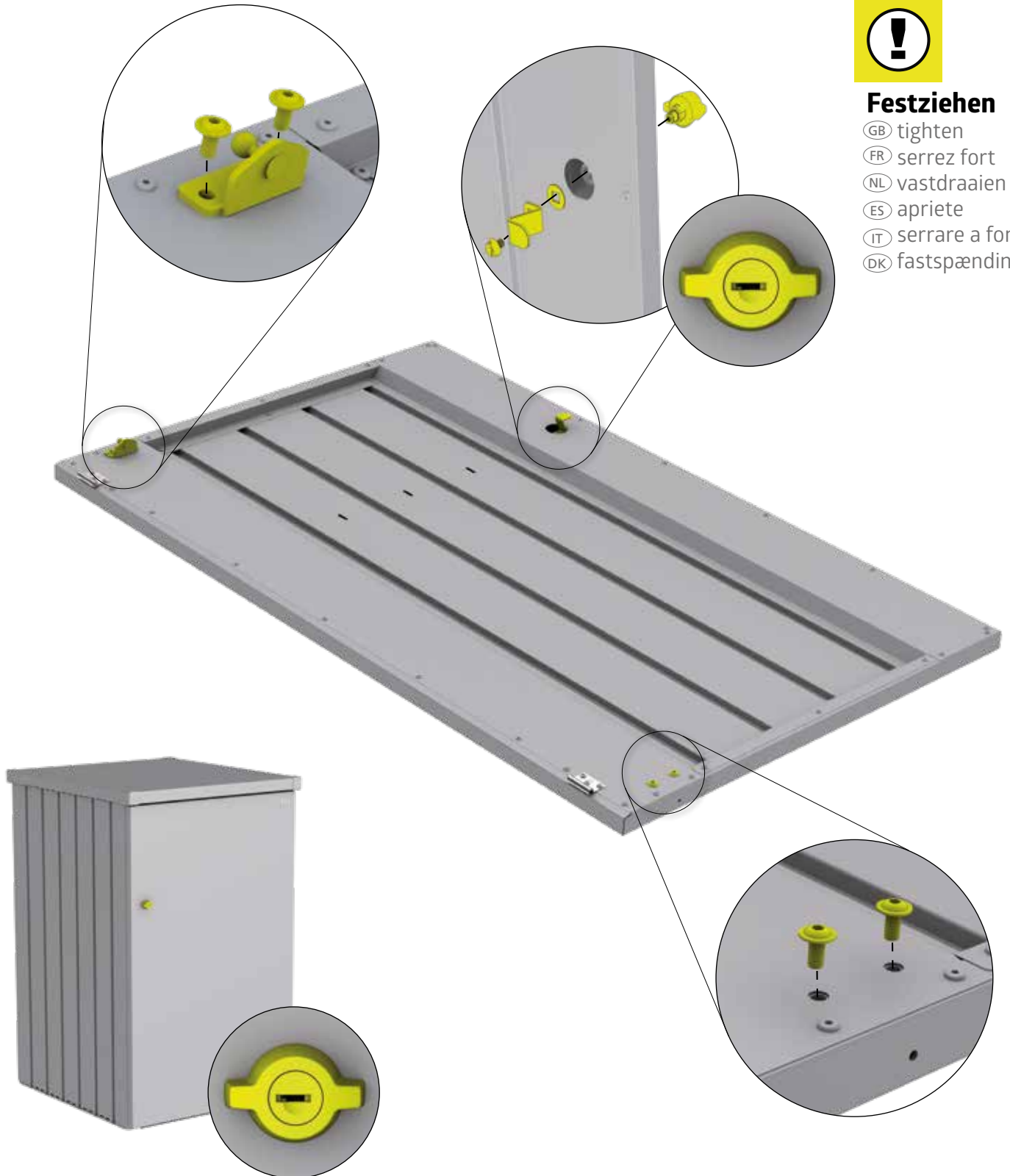

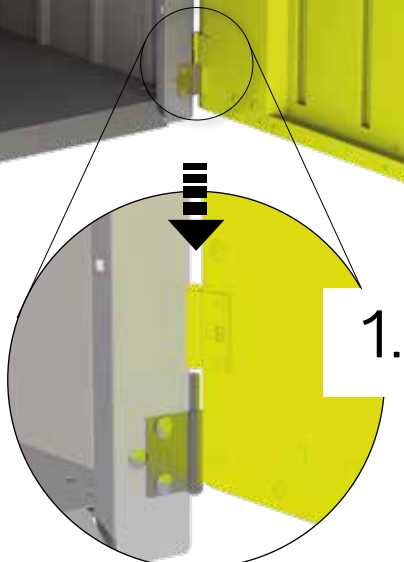
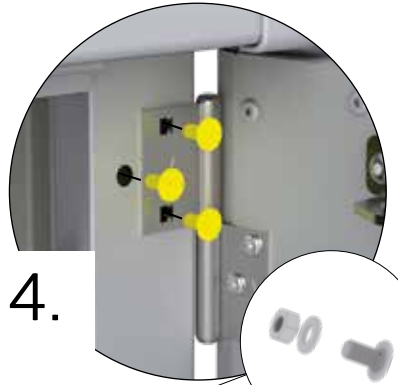
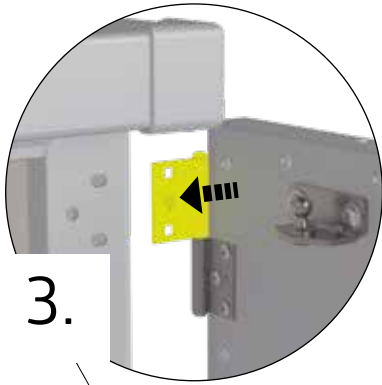
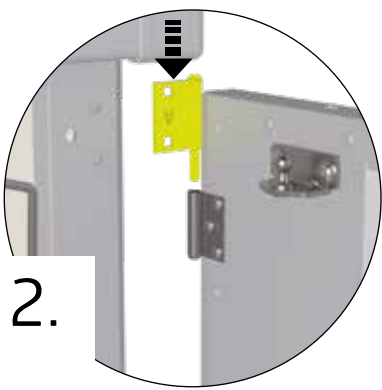
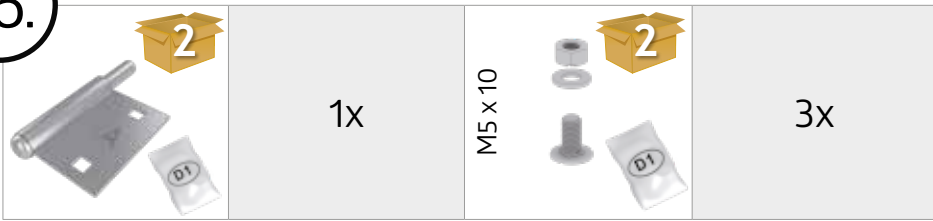

16.



17.

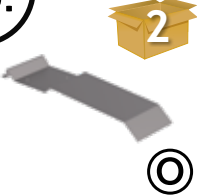

18.

	2x	4,8 x 13		4x
---	----	----------	---	----



Option A

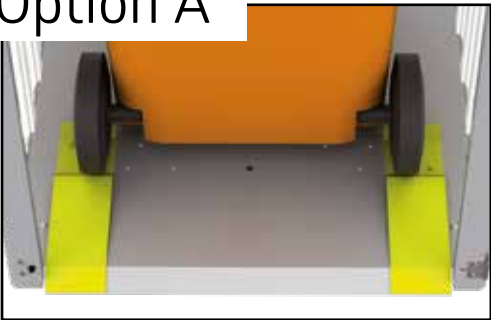

Option B

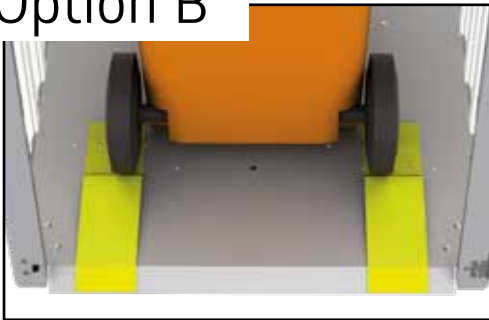

Option C

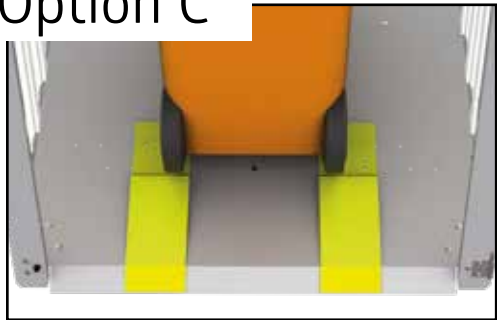

Position der Bodenschienen an die Größe der Mülltonne anpassen.

Ⓒ Adjust the position of the bottom rails to the size of the dustbin.

Ⓕ Ajustez la position des rails au sol à la taille de la poubelle.

19.

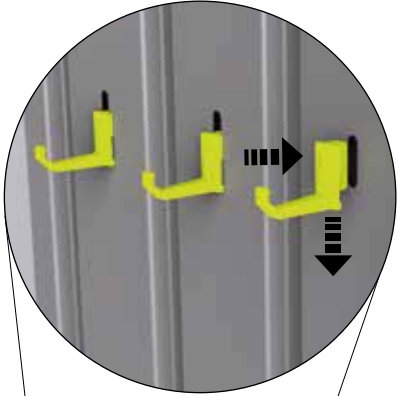

20.

Ziehen Sie jetzt alle Schraubverbindungen fest an!

Tighten now all nuts and connections securely! - Serrez maintenant les vis à fond! - Draai nu alle schroeven vast! - Ahora puede apretar y fijar todos los tornillos y tuercas - Adesso serrare a fondo tutti i dadi - Fastspænd nu alle bolt-/skruerforbindelser!



1. Rechtwinkelig einrichten



- Ⓒ rectangular adjusted
- Ⓕ ajuster en forme rectangulaire
- Ⓖ rechthoekig instellen
- Ⓔ ajustar en forma rectangular
- Ⓗ mettere in forma rettangolare
- Ⓙ indstil vinkelret

2. Tür einrichten

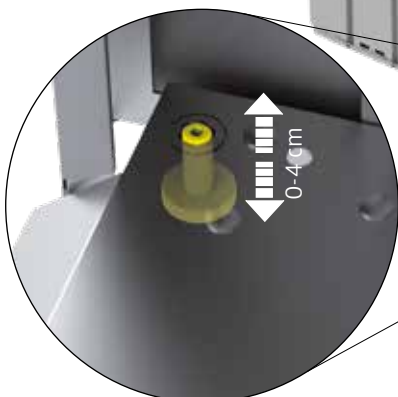
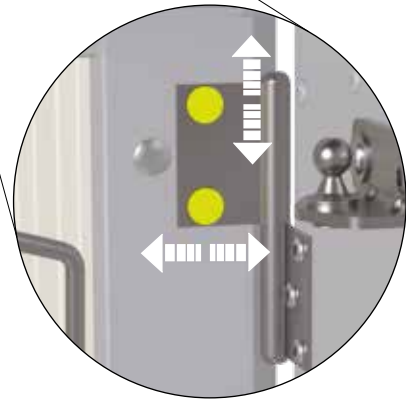
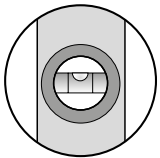
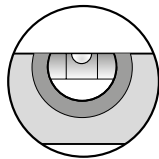
- Ⓒ align the door
- Ⓕ ajuster la porte
- Ⓖ deur afstellen
- Ⓔ ajuste la puerta
- Ⓗ aggiustare la porta
- Ⓙ justering af dør

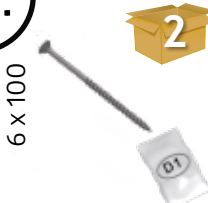

21.

 <p>6 x 100</p>	<p>4x</p>		<p>4x</p>		<p>5x</p>
--	-----------	---	-----------	---	-----------

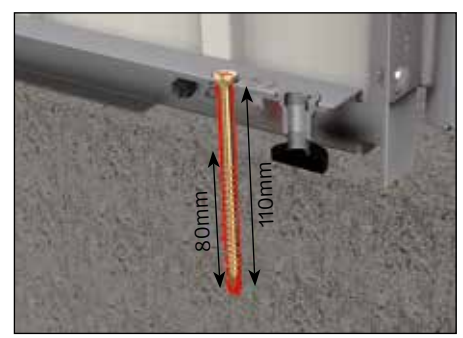
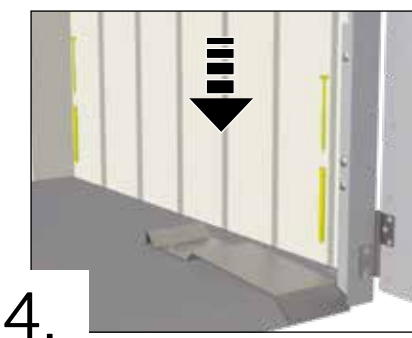
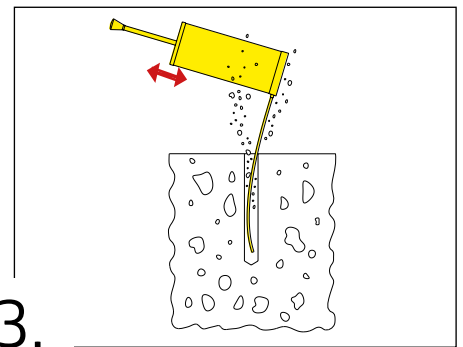
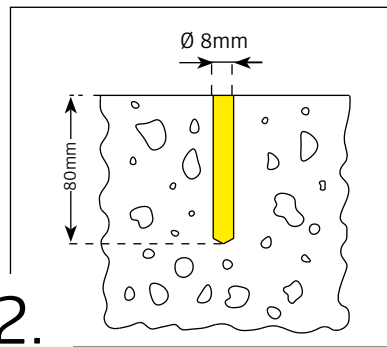
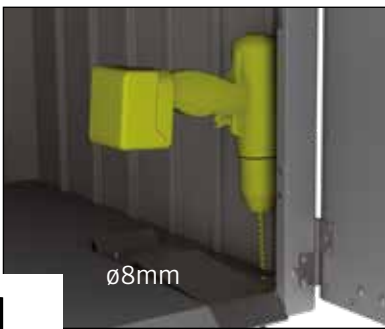
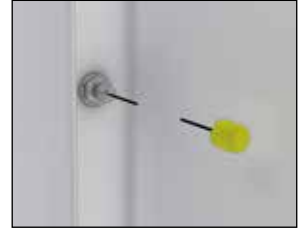

22.





GERÄTEHÄUSER – Setzen Sie auf Qualität & Langlebigkeit
GARDEN SHEDS – rely on quality & longevity



GARTENBOXEN – Outdoorboxen für Garten, Terrasse & Co.
OUTDOOR BOXES – outdoor boxes for garden, patio & more



FAHRRAD-GARAGEN – Fahrräder, Roller & Co sicher verstaut
BICYCLE STORAGE – for safe storage of bicycles, scooters & more



MÜLLTONNEN-BOXEN – Stylish, praktisch & wartungsfrei
DUSTBIN STORAGE – stylish, practical & maintenance free



GARTEN-HELFER – Gartendesign in Bestform
GARDENING HELPERS – garden design at its best

Kontrollnummer:
 Control-number / Contrôle-Qualité / Controlnummer:



Bei Reklamationen bitte anführen:
 Kontrollnummer und Artikelnummer des reklamierten Teils.

GB: In case of complaint please indicate the control-number and the number of the item, which is subject of complaint.

F: Pour toutes réclamations: prière de joindre le numéro de contrôle et le numéro d'article de la pièce litigieuse.

NL: Bij reclamaties svp doorgeven: controlnummer en artikelnummer van het desbetreffende onderdeel.



Biohort steht für
 „LEBEN IM GARTEN“

Biohort stands for
 „LIFE IN THE GARDEN“

follow us:



Biohort GmbH
 Pürnstal 43, 4120 Neufelden, Österreich
 Tel: +43-7282-7788-0
 E-Mail: office@biohort.at, www.biohort.com