

17555-15

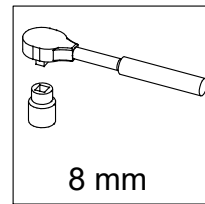
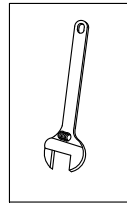
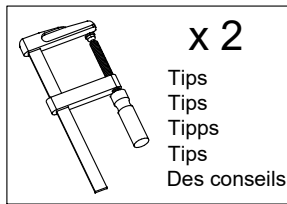
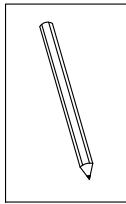
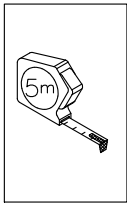
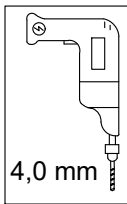
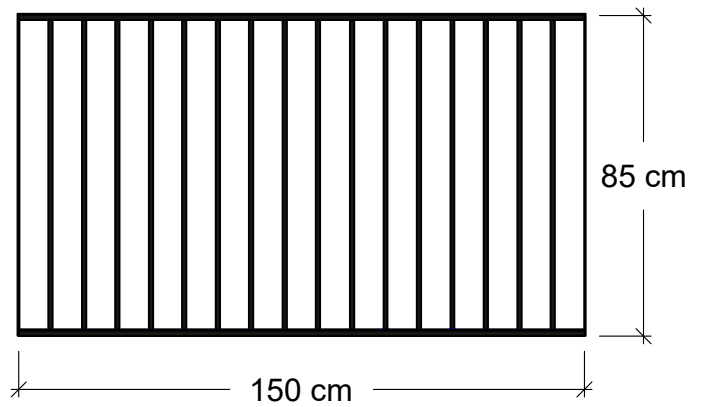

Vi anbefaler at være to personer til samling/montering af produktet.

We recommend two people for assembly/mounting of the product.

Wir empfehlen, dass die Montage des Produktes von zwei Personen durchgeführt wird.

Nous vous recommandons d'être à deux pour procéder à l'assemblage/au montage du produit.

Vi rekommenderar att man är två personer för montering/installation av produkten.

C x 1

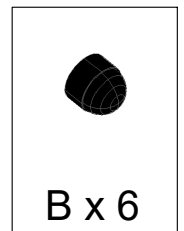
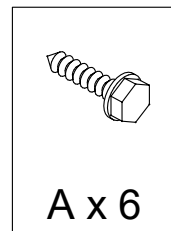
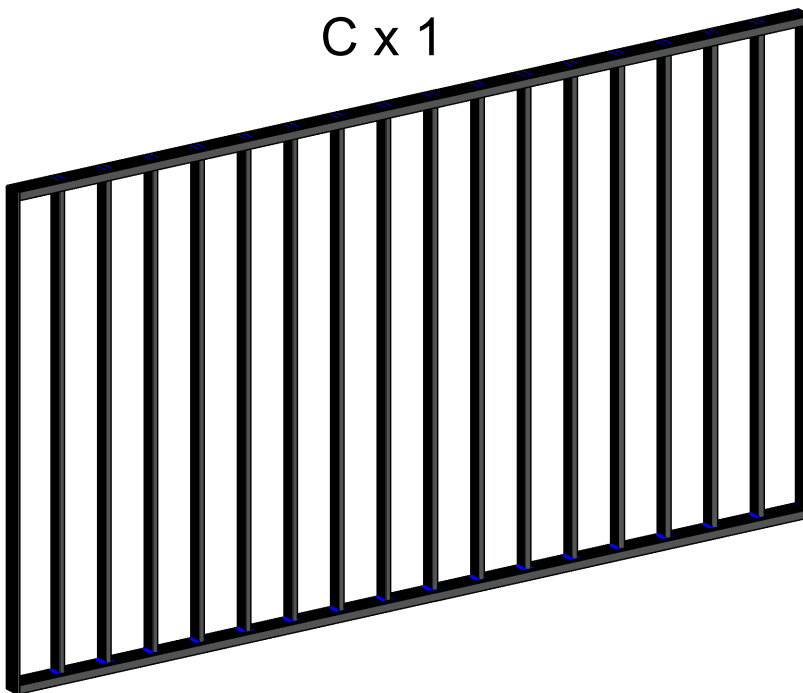

PLUS

PLUS A/S

Ådalen 13B

DK-6600 Vejen

phone: +45 7996 3333

web: www.plus.dk

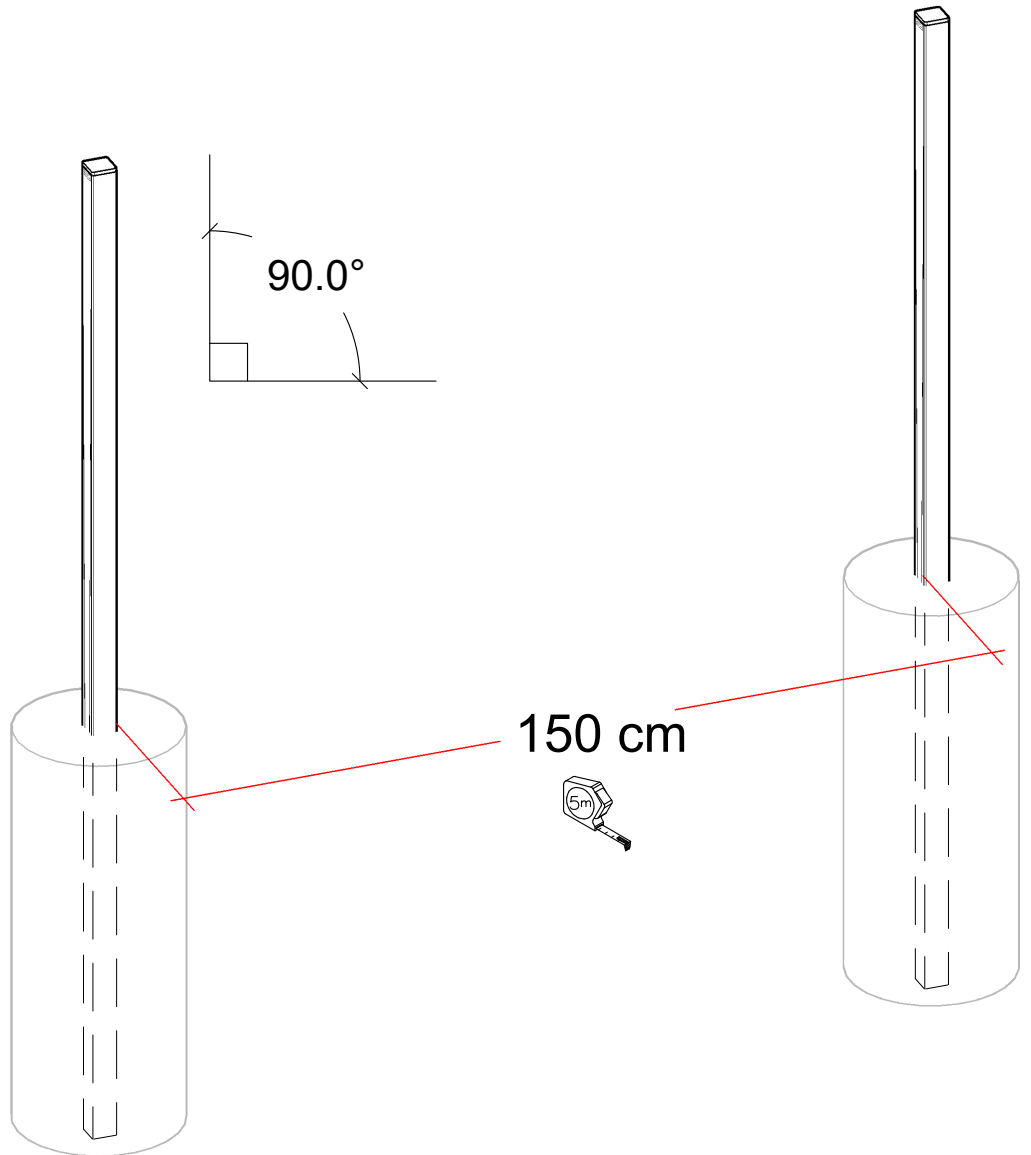
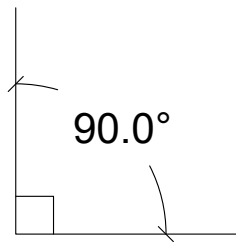
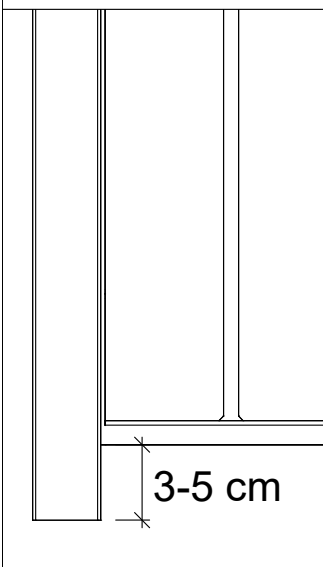
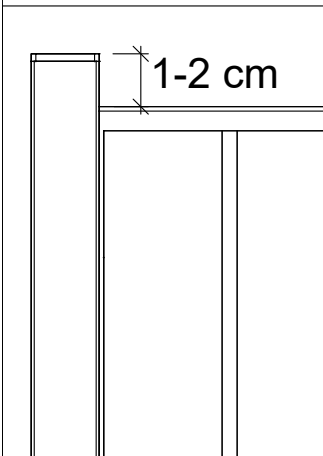
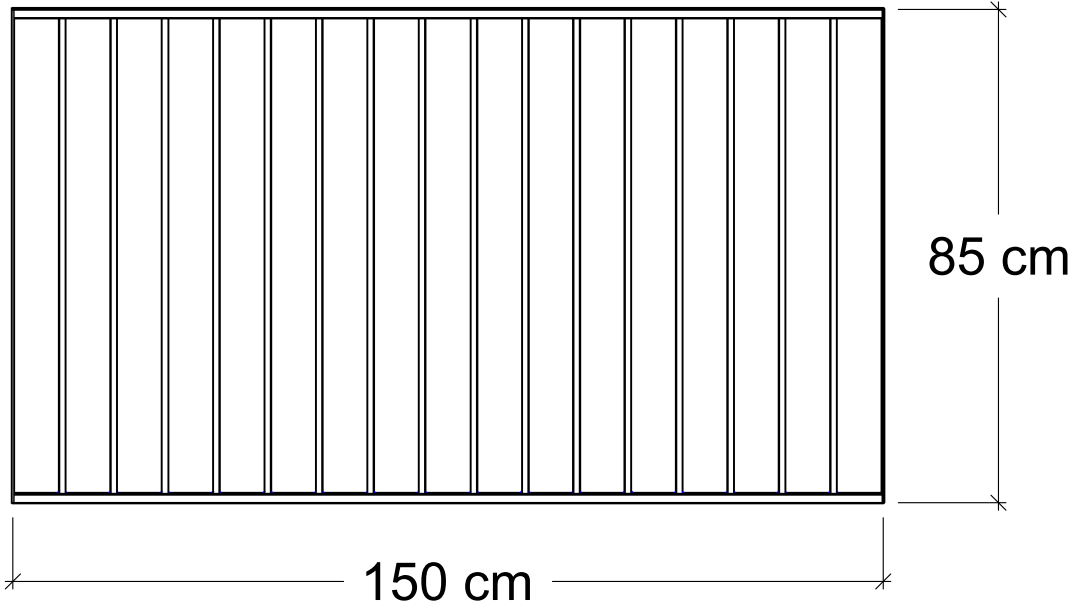
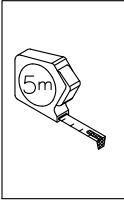

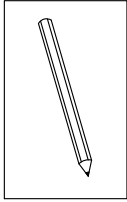
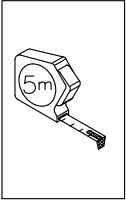

- DK:** Afmærk på stolpen, hvor hegnet skal monteres.
UK: Mark the post where the fence must be mounted.
DE: Am Pfosten markieren wo der Zaun (Beschlage) montiert werden soll.
F: Marquer l'endroit o la barrire doit tre monte!
S: Markera stolpa dr staketet mste monteras.

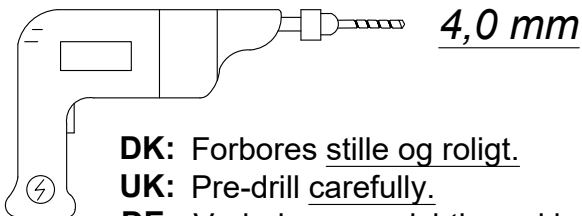
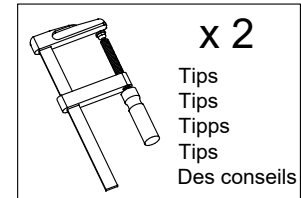
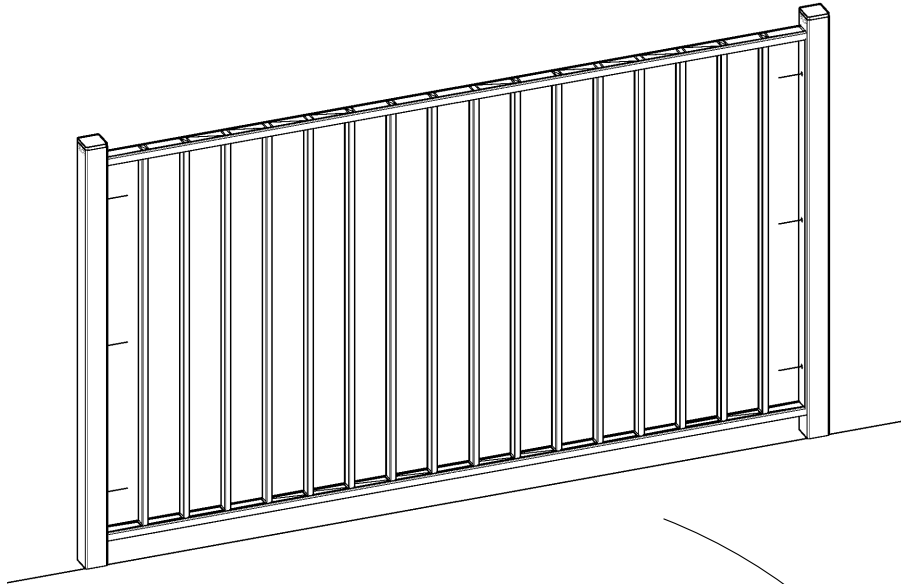

- DK:** Forbores stille og roligt.
UK: Pre-drill carefully.
DE: Vorbohren vorsichtig und langsam.
F: Pr-percer soigneusement.
S: Frborra lugnt och frsiktigt.

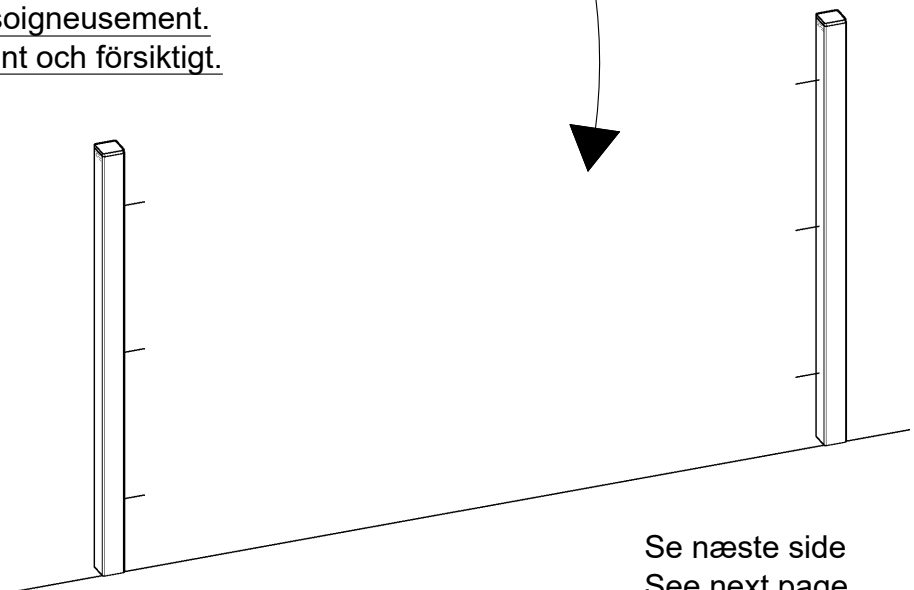

Se nste side
See next page
Siehe nchste Seite
Voir page suivante
Se nsta sida



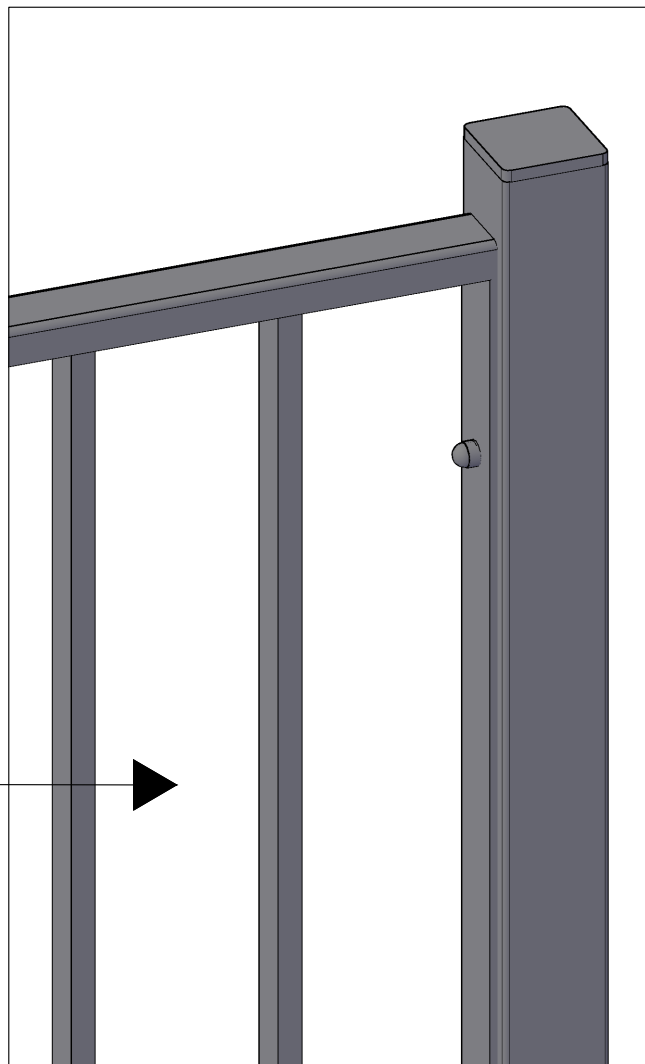
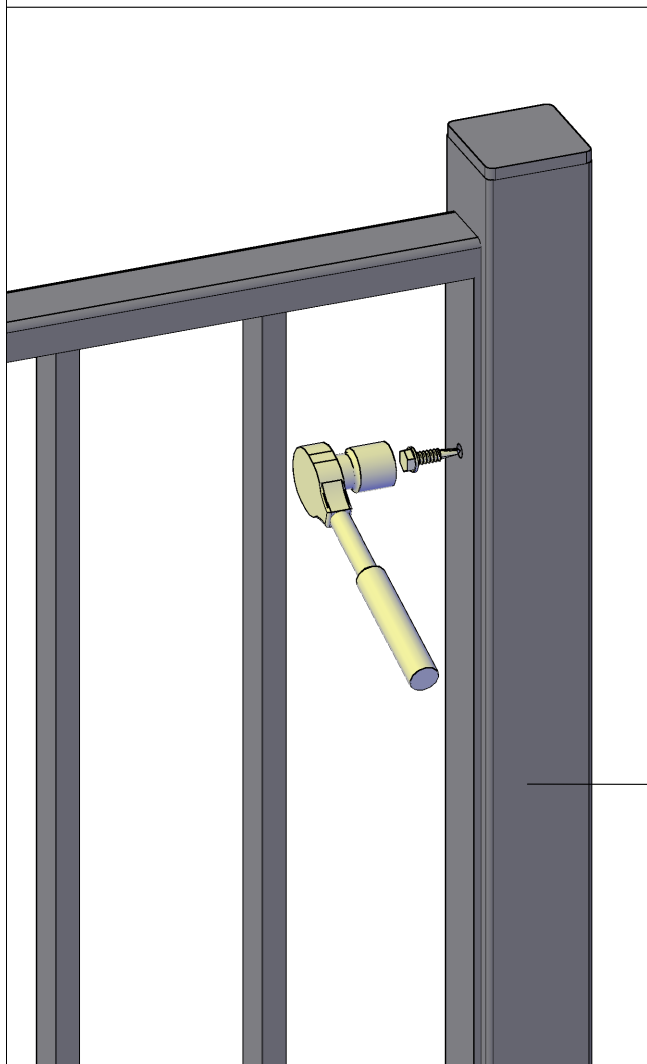
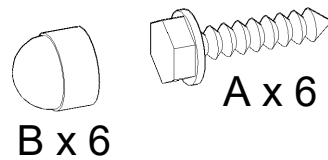
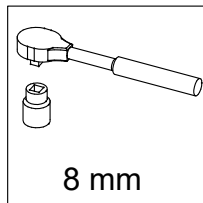
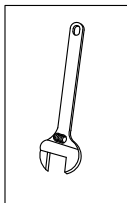

Se www.plus.dk for yderligere information og vedligehold af materialer.

See www.plus.dk for additional information and maintenance of materials.

Weitere Informationen sowie Wartungsanweisungen für die Materialien erhalten Sie auf www.plus.dk.

Se reporter au site www.plus.dk pour de plus amples informations et pour l'entretien des matériaux.

Se www.plus.dk för ytterligare information och materialunderhåll.