

KNAUFDANOLINE

DANOloft®

PRE-PAINTED ACOUSTIC GYPSUM PANELS
WITH CONCEALED FIXING





**IT'S NEVER BEEN EASIER
TO ACHIEVE A STUNNING
ACOUSTIC CEILING**

DANOloft® pre-painted gypsum panels offer a beautiful ceiling and wall surface with excellent acoustic properties. Once the DANOloft® panels are screw-fixed, your surface is finished - no painting or filling required. DANOloft® panels are suitable for a wide range of applications, e.g. open plenum, lounges, exposed structures, skin to the slab constructions, etc.



A CEILING WITH MULTIPLE BENEFITS

TURN UP THE SPEED

- Simple screw fixing
- No painting or filling
- Easy to demount or replace

TURN UP THE DESIGN

- Monolithic surface
- Almost invisible screws
- Paintable on site to cater to interior demands

TURN UP THE ACOUSTICS

- Unrivalled acoustic effect
- Repaintable without loss of acoustics
- Healthy indoor climate with Cleaneo technology

TURN UP THE SUSTAINABILITY

- Made from glass fibre reinforced gypsum
- Safe, natural material
- 100% recyclable

SIMPLE DESIGN

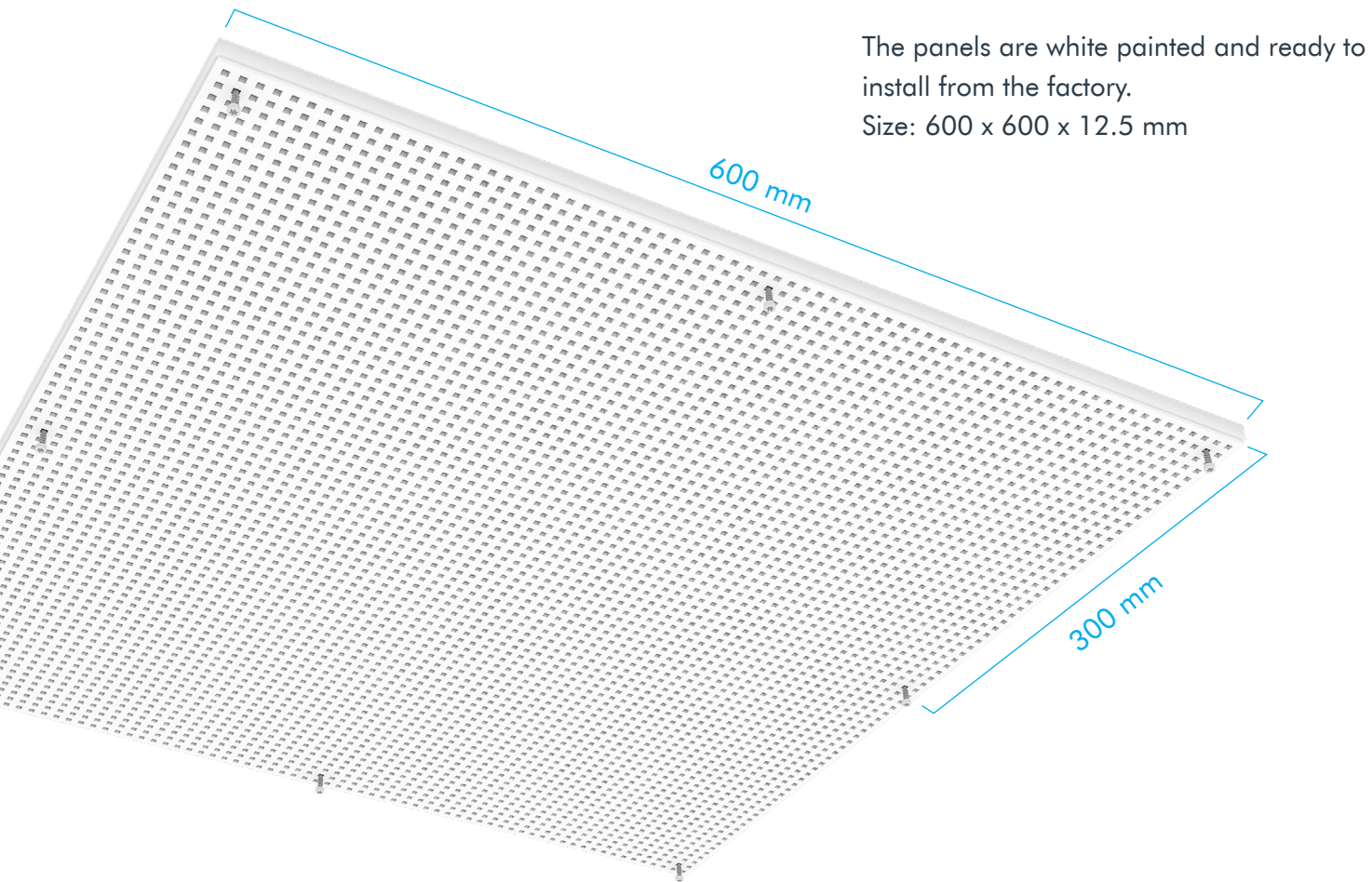

The panels are white painted and ready to install from the factory.
Size: 600 x 600 x 12.5 mm

A PERFECT FINISH



DANOlloff® screw has a white-painted head, making it almost invisible when flush with the tile surface.
Size: 4.5 x 28 mm

ADVANCED FUNCTION

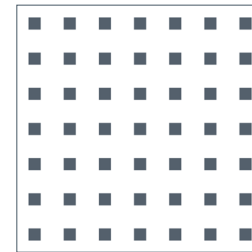
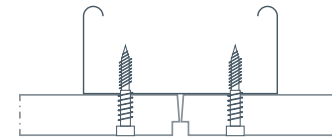

EDGE B+

discreet joints
screw-fixing through perforations
installation on steel or wood furring
application as wall or ceiling cladding

UNITY 3 PERFORATION

3.5 x 3.5 mm square holes, c/c 8.33 mm
perforation to the edge of panel
17.2% perforation area

ACOUSTICS

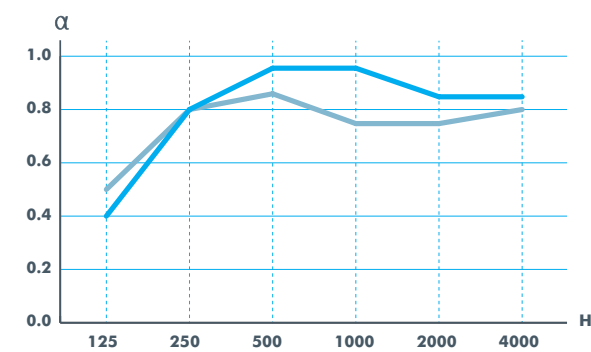

Hz	65 mm suspension, 45 mm mineral wool	200 mm suspension, no mineral wool
125	0.40	0.50
250	0.80	0.80
500	0.95	0.85
1000	0.95	0.75
2000	0.85	0.75
4000	0.85	0.80
α_w	0.95	0.80
NRC	0.90	0.80

PANEL WEIGHT

9.2 kg / m³

SURFACE TREATMENT

Front: White acrylic paint, RAL 9003, gloss 5.
Back: Acoustic felt backing.
Available in other colours on request and repaintable on site.

FIRE RATING

A2-s1, d0
Class 1; K₁10, A2-s1, d0
UL-listed in accordance to R26164

LIGHT REFLECTION

69.2%

LOAD-BEARING CAPACITY

Up to 3 kg per panel.

AMBIENT CONDITIONS

Can withstand:
- constant RH 70% and 25°C
- periodic RH 90% and 30°C
- ambient temperatures of up to 50°C.

INDOOR AIR QUALITY

Certified according to Danish Indoor Climate Labelling:
Indoor value: 10 days
Particle emission: LOW

AIR PURIFICATION

Air purification with Cleaneo technology

HYGIENIC SURFACE

Also available with hygienic Medifend surface paint on request. Medifend has antibacterial and fungistatic effect. Tested in accordance with DIN ISO 846, method B and B'.

ROBUSTNESS

Glass fibre reinforced gypsum. High pressure resistance.

SUSTAINABILITY

Made from gypsum - a natural, 100% recyclable material.

CEILING INSTALLATION

Best practice: Use of clean cotton gloves when handling the panels will ensure a ceiling without fingermarks.

1A INSTALLATION OF CD-PROFILES



- Install hangers pr. max. 900 mm.
- Suspend primary CD profiles pr. max. 900 mm.
- Attach secondary CD profiles pr. max. 300 mm.

1B INSTALLATION OF P45-S25 PROFILES

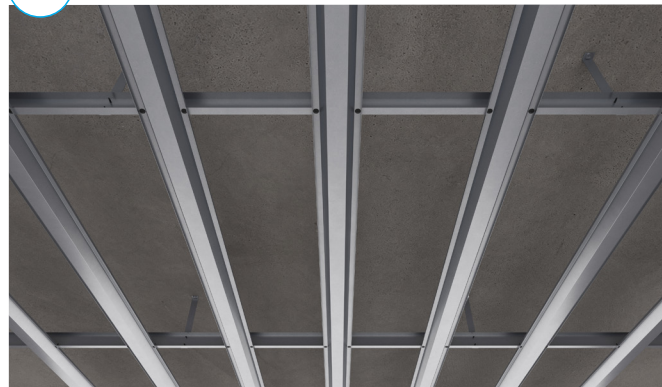

- Fix P45 primary profiles pr. max. 1000 mm.
- Attach S25/85 secondary profiles pr. max. 300 mm.

2 PLACING THE SCREWS

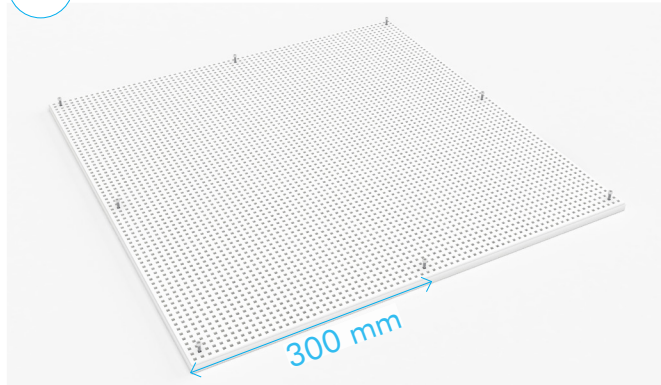

- Insert screws in 2nd perforation row (8 screws per panel).

3 CEILING LAYOUT

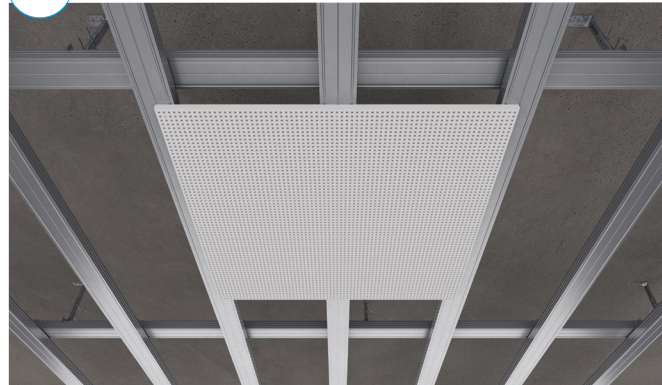

- Place the panel in the centre of the ceiling surface. Hold the panel tight against the furring and install according to the layout. For installation pattern options, please go to page 11.
- Use a straightedge to set the direction.
- Start the installation by fixing 2 full rows of panels lengthwise to ensure correct direction of ceiling panels.

4 TIGHTENING OF SCREWS

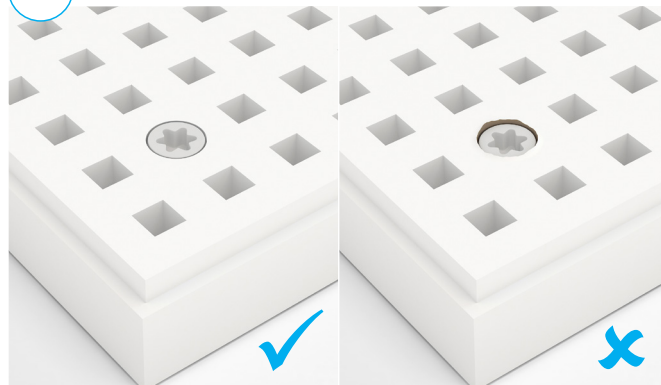

- **IMPORTANT** – the head of the screw must be levelled with the surface of the panel. Use a cordless screw-driver and adjust the speed to LOW.

5 ADJUSTING PERIMETER

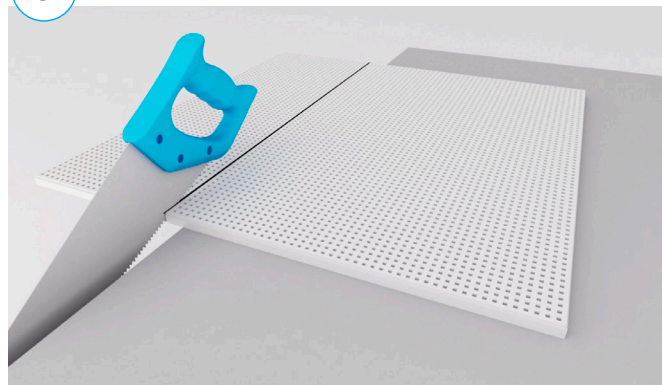

- Cut perimeter panels 2-3 mm shorter than the gap between the last full-size panel and the adjacent building component.
- Cut the elements from the front with a fine-toothed saw.
- Sand the edges with fine sand paper.

6 INSTALLATION OF ADJUSTED PANELS

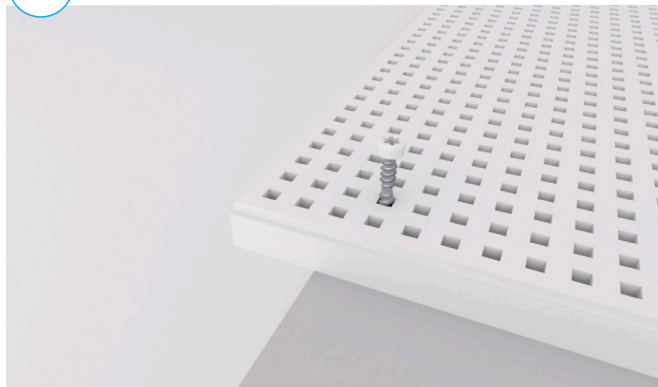

- Place the screws in 4th or 5th perforation row of the adjusted panel for easier screw-fixing.

7 FINISHING AGAINST THE WALL



- Finish the surface using silicone sealant around the perimeter.

DANOloft® ACCESS PANEL

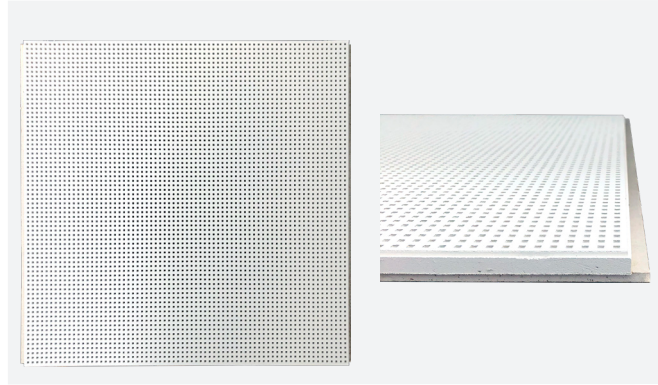

- DANOloft® access panel with a 6mm gypsumboard backing to support the DANOloft® panel. No fixing required. Access panel is demounted by pushing the panel and lifting it over the adjacent DANOloft® panels.

KNAUF DANOLINE ACCESS PANEL

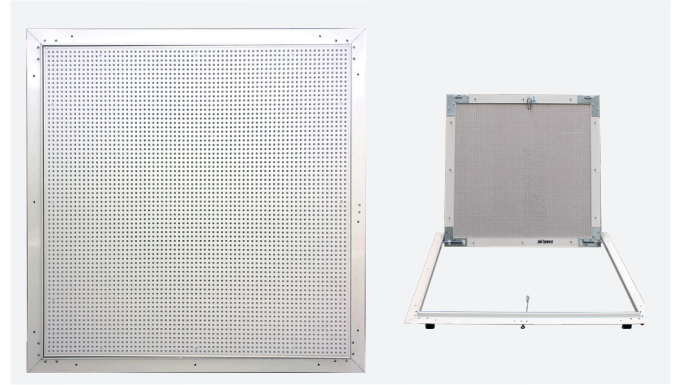

- DANOloft® panel is framed and hinged into a steel profile of the Knauf Danoline access panel which is fixed in adjacent DANOloft® panels.

WALL INSTALLATION

Best practice: Use of clean cotton gloves when handling the panels will ensure a wall without fingermarks.

1A INSTALLATION OF CD-PROFILES

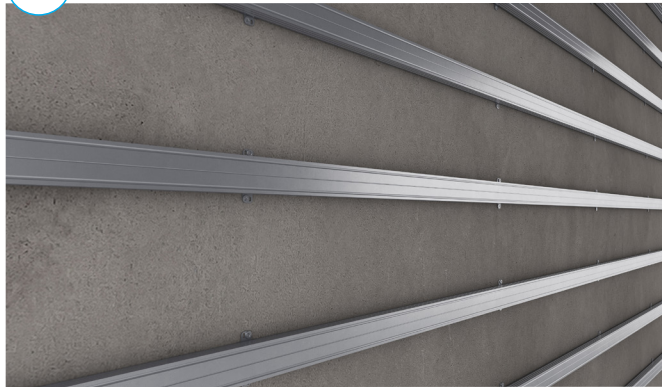

- Install UD profiles around the wall cladding area (top, bottom, and sides).
- Fix direct hangers to the wall pr. max. 900 mm.
- Install CD-profiles c/c 300 mm.

1B INSTALLATION OF S25 PROFILES

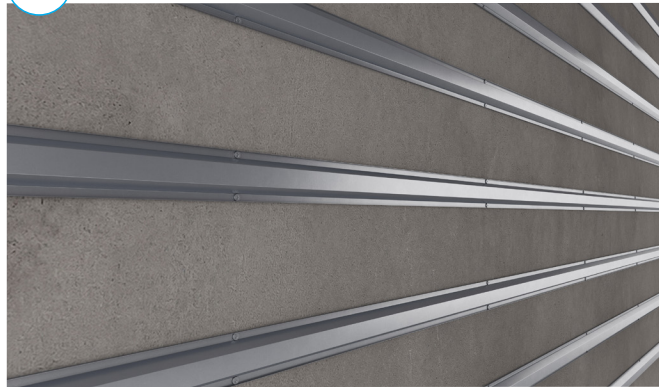

- Install SK25 profiles at the top and bottom of the wall cladding area.
- Fix S45 primary profiles pr. max. 300 mm.

2 PLACING THE SCREWS

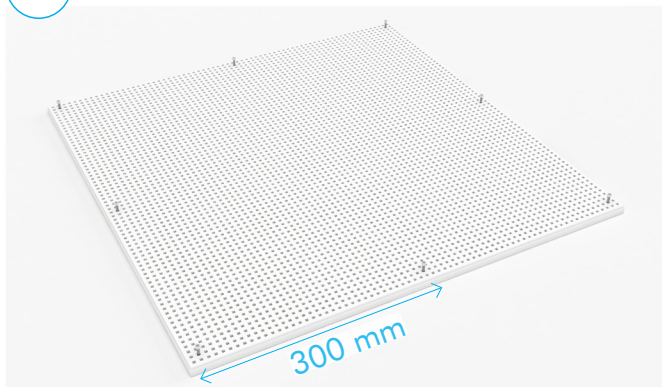

- Insert screws in 2nd perforation row (8 screws per panel).

3 WALL LAYOUT

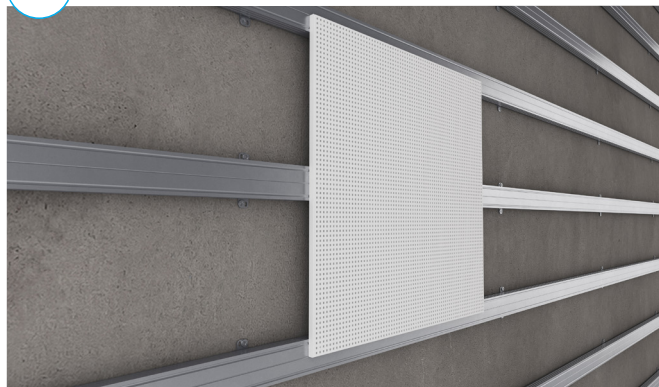

- Place the panel in the centre of the wall cladding area. Hold the panel tight against the furring and install according to the layout. For installation pattern options please see next page.
- Use a straightedge to set the direction.
- Start the installation by fixing 2 full rows of panels lengthwise to ensure the correct direction of the panels.
- 45 mm mineral wool backing is optional for maximising sound absorption.

4 TIGHTENING OF SCREWS

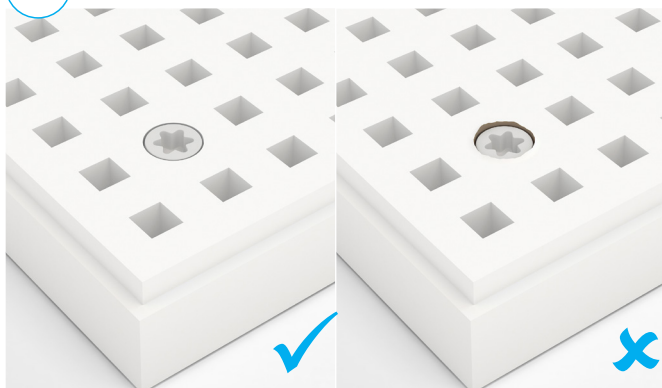

- **IMPORTANT** – the head of the screw must be levelled with the surface of the panel. We recommend using a cordless screw-driver and adjust the speed to LOW.

5 ADJUSTING PERIMETER

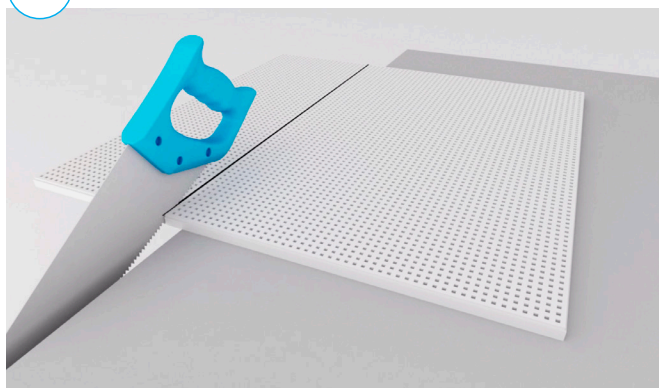

- Cut perimeter panels 2-3 mm shorter than the gap between the last full-size panel and the adjacent building component.
- Cut the elements from the front with a fine-toothed saw.
- Sand the edges with fine sand paper.

6 INSTALLATION OF ADJUSTED PANELS

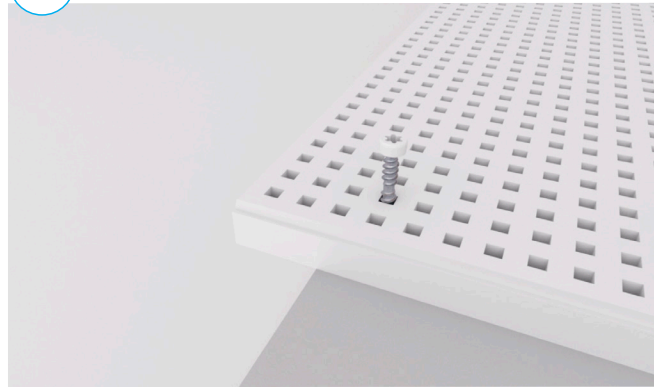

- Place the screws in 4th or 5th perforation row of the adjusted panel for easier screw-fixing.

STAGGERED INSTALLATION PATTERN



- Staggered installation pattern is achieved by staggering the panel rows.

7 FINISHING AROUND THE WALL

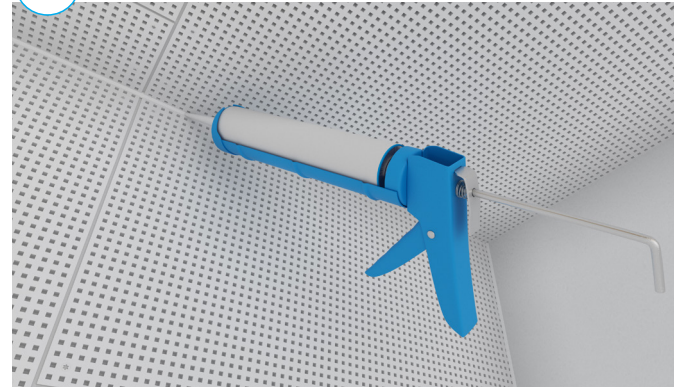

- Finish the surface using silicone sealant around the perimeter.

STRAIGHT INSTALLATION PATTERN

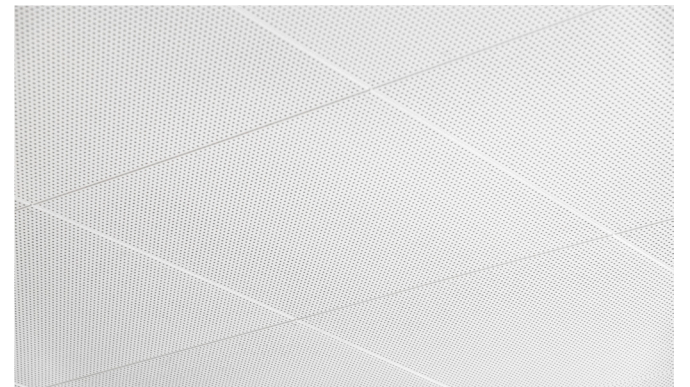

- Straight installation pattern is achieved by installing the panels edge to edge.

See more on
KnaufDanoline.com/DANOloft

KNAUF **DANOLINE**

Knauf A/S | Kløvermarksvej 6 | 9500-Hobro | Denmark | +45 96573000