

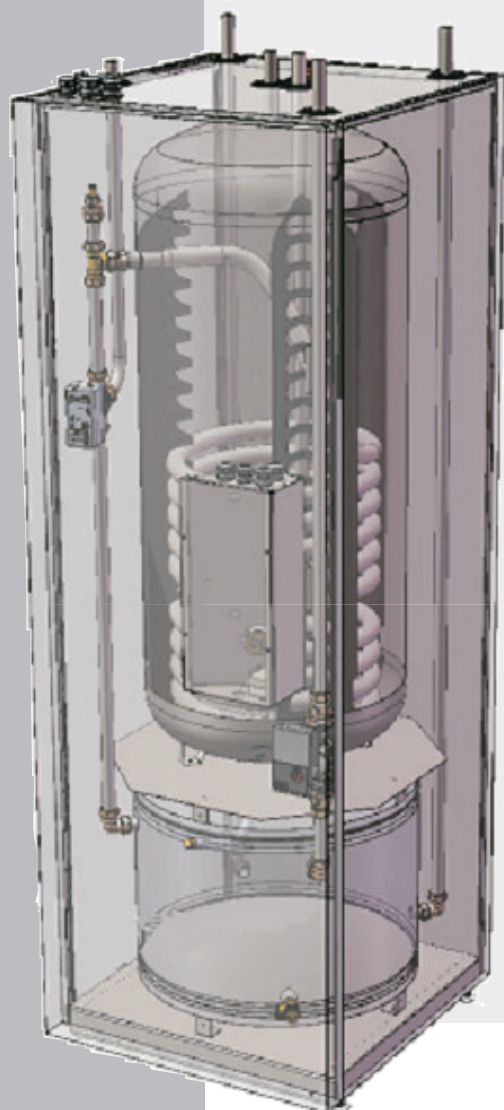

PAW-TD20B8E3-2



Technical Data Manual

Table of contents

Dear customer... _____	2
Important information  _____	2
Drawing _____	3
Technical data _____	3
ErP data _____	3
Components _____	4
Transport and package _____	4
Area and placement of the tank _____	4
Before installation Heating and Hot water _____	4
Removing the front cover _____	5
Installation, Heating and Domestic water  _____	5
Installation, Electrical wiring _____	6, 7
Maintenance _____	8
Check manometer 2 times/year _____	8
Check safety valve 2 times/year _____	8
Cleaning the particle filter 2 times/year _____	8
Check the protective anode _____	8
Spare parts _____	9
Warranty and product liability _____	10

Dear customer...



PAW-TD20B8E3-2 is a modern technology tank with good performance and very low heat losses, which supply your household with hot water and heating to radiators / underfloor heating. The water heater is made of vitrified steel and has a non-toxic polyurethane insulation on 50mm. The lower buffer tank at 80L reduces start and stop sequences on air / water pump for increased lifespan, improved energy efficiency and greater comfort.

Important information



In order to avoid hazards, please read the installation manual carefully before beginning installation. Incorrect repairs may lead to danger to users. Only trained and qualified technicians are authorized to install, move, modify or repair this product. If these regulations are not complied with, visits from an authorized service technician to carry out adjustments or repairs may be charged, even during the warranty period. The warranty does not apply if the applicable regulations are not complied with. Persons with learning difficulties or disabilities may not use the unit unless they have been instructed in how to use it in a safe way. Children must not be allowed to play with the equipment. Keep an eye on them! The tank must not be stored outdoors before installation. Always wear gloves during installation or repair. Touching the pipes may lead to hot or cold burns. Means of disconnection must be supplied for the fixed installation, in accordance with the installation norms.

Drawing

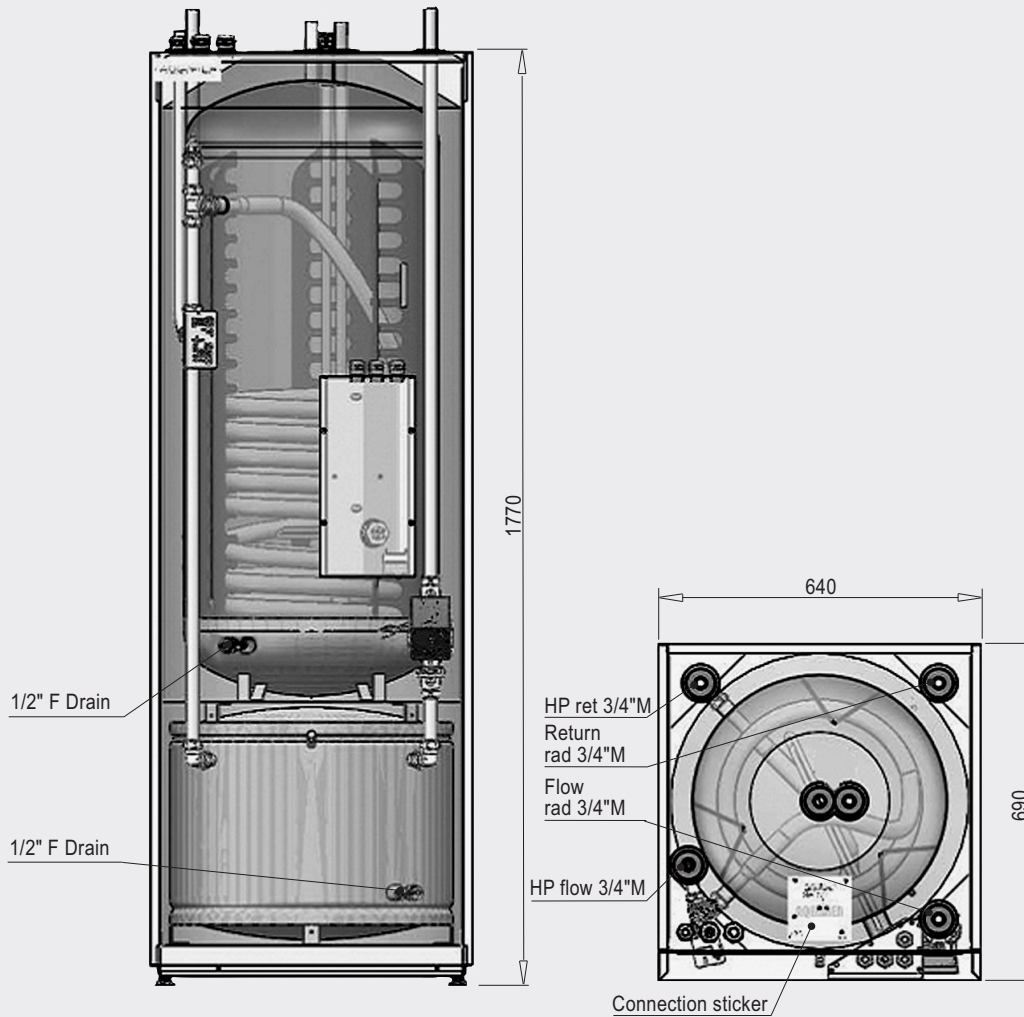

Technical data

HxWxD (Cabinet measurement)	mm	1770x640x690	
Weight (empty)	kg	150	
Volume	lit	185	
Power supply	V, Phase, Hz	230, 1, 50	
Hot water tank	Volume	lit	185
	Max working pressure	Mpa (bar)	1,0 (10)
	Pressure test	Mpa (bar)	1,5 (15)
	Max working temp	°C	90
	Connections	"M	3/4
	Material		S 275 JR vitrified
	Insulation	Material, t=mm	PUR, 50
	Heating coil surface	m ²	2.1
	Electrical heater	W	3000
	Energy loss at 65°C	kWh/24h	1,3
Buffertank	Volume	lit	80
	Max working pressure	Mpa (bar)	0,6 (6)
	Pressure test	Mpa (bar)	0,9 (9)
	Max working temp	°C	100
	Connections	"M	3/4
	Material		S235 JR
	Insulation	Material, t=mm	PUR 40mm

ErP data

		Hot water tank 185	Buffertank 80
Supplier's model	PAW-TD20B8E3-2		
Energy efficiency class (A+...F-)		B	B
Standing loss	W	53	46
Storage volume	lit.	185	80

1) EU Regulation 812/2013, 2) Tested pursuant to EN 12897:2006

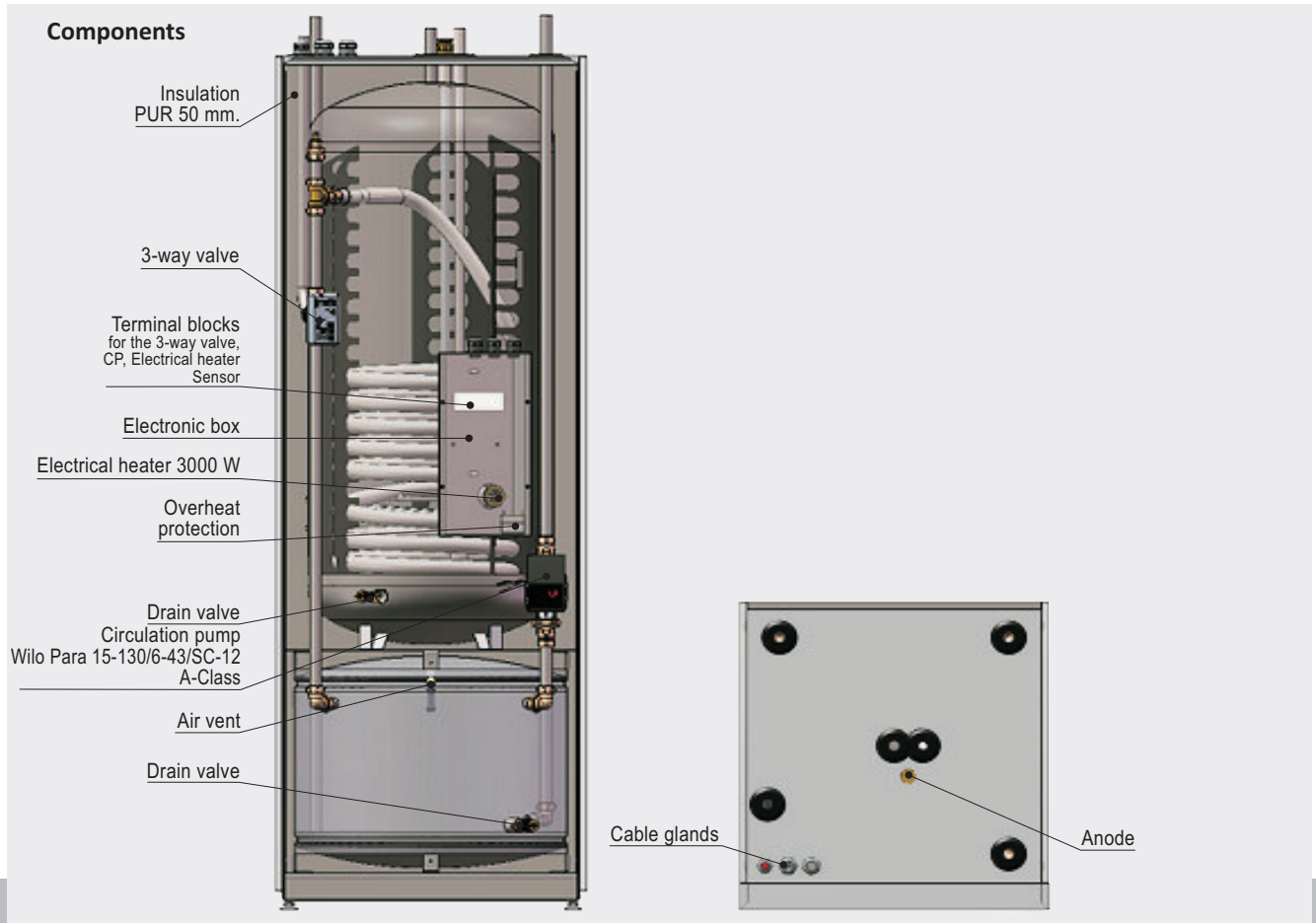

Transport and package

Be careful during transportation of the tank unit.

- The tank unit is very heavy. Don't try to lift it alone!
- To avoid injuring your hands, wear gloves when moving the tank or removing the packaging.
- Be careful not to damage the tank unit when you remove the packaging.
- To avoid damage, drain an installed tank before moving.

Area and placement of the tank

Heat pump tank must be placed so that the service can be performed. There should be a space of 1200mm in front of the tank. The minimal space above the tank unit must not be less than 600 mm to enable the protective anode to be checked.

- The surrounding space must be dry, clean, free of vapor, volatile oils, smoke and gasses or the capacity may decrease considerably and internal parts may be damaged.
- The tank unit must be installed on a firm surface that tolerates its weight.
- The space must be ventilated to avoid the cooling medium from exceeding safety level in event of leakage or there may be hypoxia in the space.
- The space must have a floor drain.
- The tank unit must be installed according to the instructions in order to reduce the risk of damage related to earthquakes, typhoons and storms.
- In favor, install the tank unit as close to the heat pump as possible. This limits the volume of coolant (pipe length).

Before installation Heating and Hot water



USEFUL HINTS

- Make sure you've chosen a heat pump that suits existing heating system and power equipment. The product must also suit the nominal water flow, lift height and size of the system.
- To avoid particle filter and heat exchanger from becoming clogged, the existing heating system must be thoroughly cleaned before pipes are connected and water filled in the tank.
- Only use clean water in the tank. If the water quality is poor the tank may be damaged. There is also a risk of corrosion and clogging in the heat exchanger if the water quality is not maintained.
- The water quality in the heating system must not exceed these values: Chlorine 100mg/l, Calcium 100mg/l, Iron/Manganese 0.5mg/l.
- Install the hydro unit as close to the heating system as possible in order to limit pressure loss, e.g. if the heating system has a large volume.
- Use mechanical overheating protection for sensitive underfloor heating systems.

Removing the front cover

1. Unscrew and remove the two screws in the lower part of the front panel.
2. Pull out the lower part of the front approx. 100-150mm.
3. Grip the sides of the front panel and lift it straight up.
4. Remove the frontpanel carefully to not damage the contact or the cable connection between the display and the control unit inside the frontpanel



Installation, Heating and Domestic water

For maximum comfort, use connectors that reduce transfer of vibration, and at the same time suites the water temperature and pressure. In order to avoid "taps" in the heating system, the pipes must be located in such way that temperature differences may be tolerated.

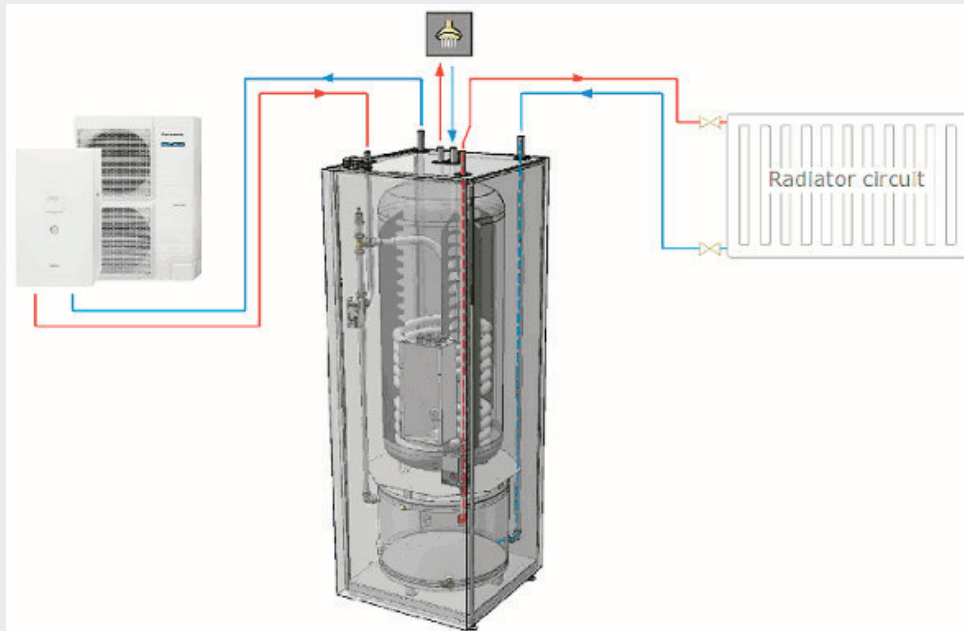

PROCEDURE

1. Put the hydro unit in position. Adjust it in level by using the screw feet. The tank must be levelled using a spirit level. This must be done before the tank is connected to the pipes and before the tank is filled with water.
2. Flush/clean the existing heating system carefully to avoid the particle filter
3. Connect the supply and return pipes to the existing heating system. The various pipes are marked on the top of the tank.
4. Connect the domestic water supply. A mixing valve is recommended to avoid scalding. A 7 bar safety valve (pressure valve) must be connected at installation. The pressure valve must be installed in a frost-free environment. (Not included).
5. Connect an escape pipe between the radiator safety valve and the floor drain, and also between the safety valve of the domestic hot water tank and the floor drain.
6. Verify if the vessel is dimensioned for the heating system (approximately 10% of the total volume)
7. Check the repressure of the expansion vessel. The pressure depends on how high the water has to be lifted.
8. Put the 3way valve manually in "fill mode" (both flow way open) and open the manual/automatic air vent.
9. Fill the radiator system and close the manual air vent.
10. Keep the pressure within recommended pressure range to prevent the water escaping through the safety valve. Restore the 3way valve in automatic position.
11. Bleed the radiators. Check the system pressure. Fill more water to the system if needed. Repeat until all air is bled.
12. Check if the diverting valve switches to radiator operation and that the radiators heat up. Bleed the system once it is warm. Check for leaks in the system.
13. Clean particle filter (see Maintenance)
14. Fill the domestic hot water tank. Open a hot water tap to ventilate.
15. Close the automatic air vent after approx. two weeks to prevent air from entering the system.

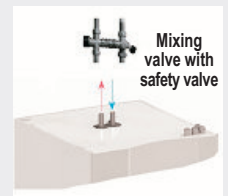

Height difference x 0.1 + 0.3 =
Pressure in the expansion vessel.

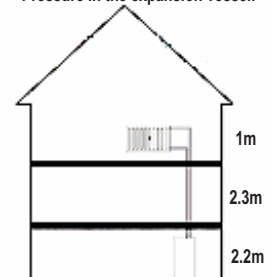

E.g. If the tank is in the basement and the radiators in the loft, the difference in height between the expansion vessel and radiators will be approx. 5.5 m

$$(5.5)0.1+0.3= 0.85 \text{ bar}$$

Installation, Electrical wiring (for Aquarea Generation F and G)

Connect the corresponding wires from the hydrobox into the electronic box inside the tank unit.

Terminal 13 and 14 at the HP must be jumpered.

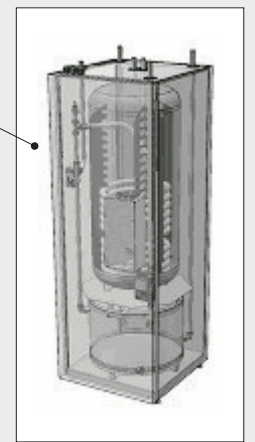
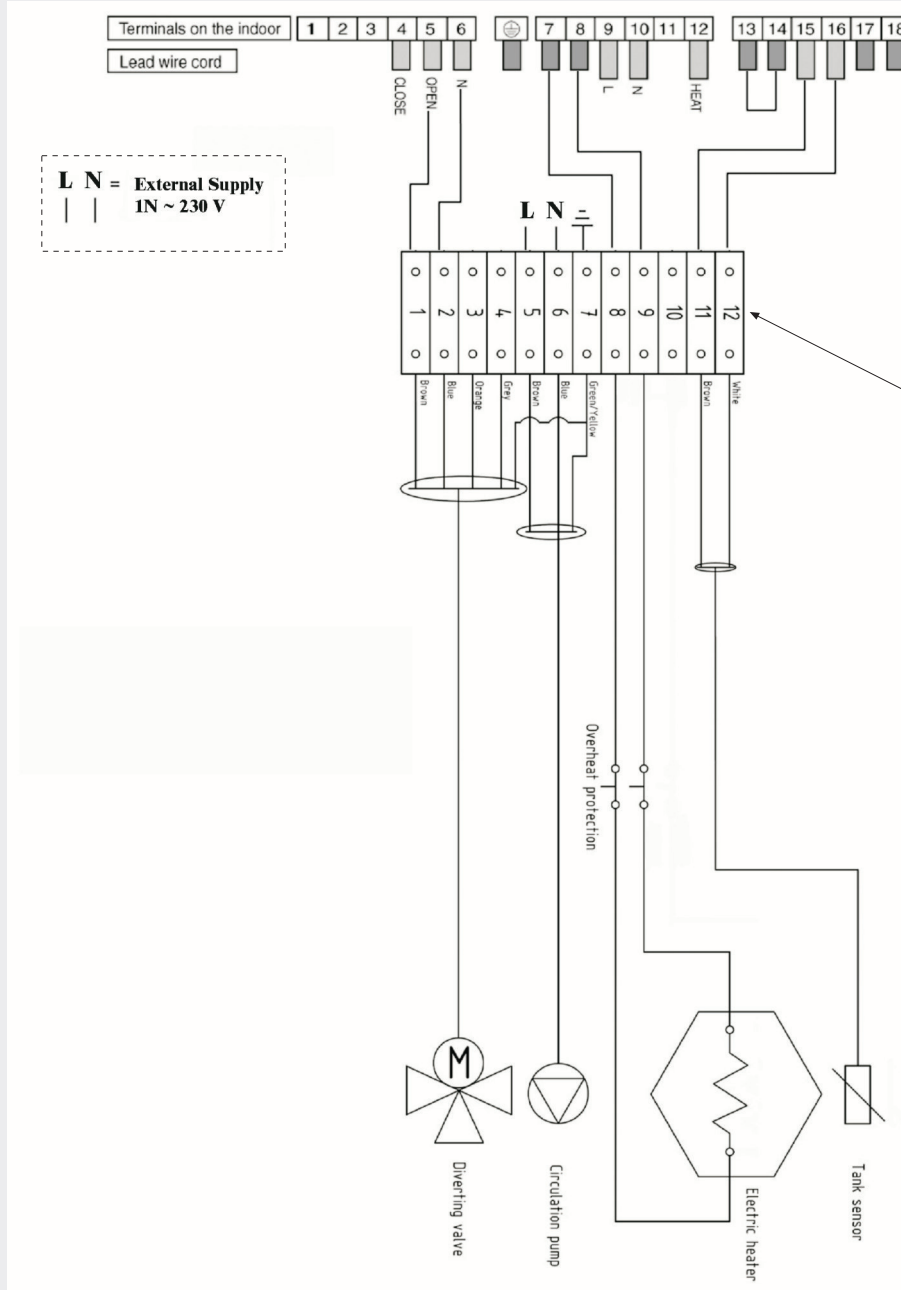

Installation, Electrical wiring (for Aquarea Generation H and J)

Connect the corresponding wires from the hydrobox into the electronic box inside the tank unit.

Terminal 13 and 14 at the HP must be jumpered.

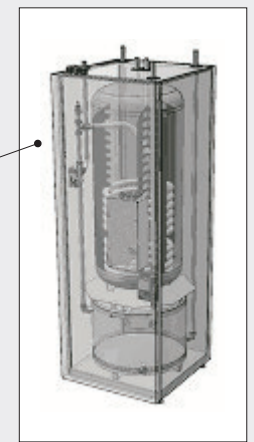
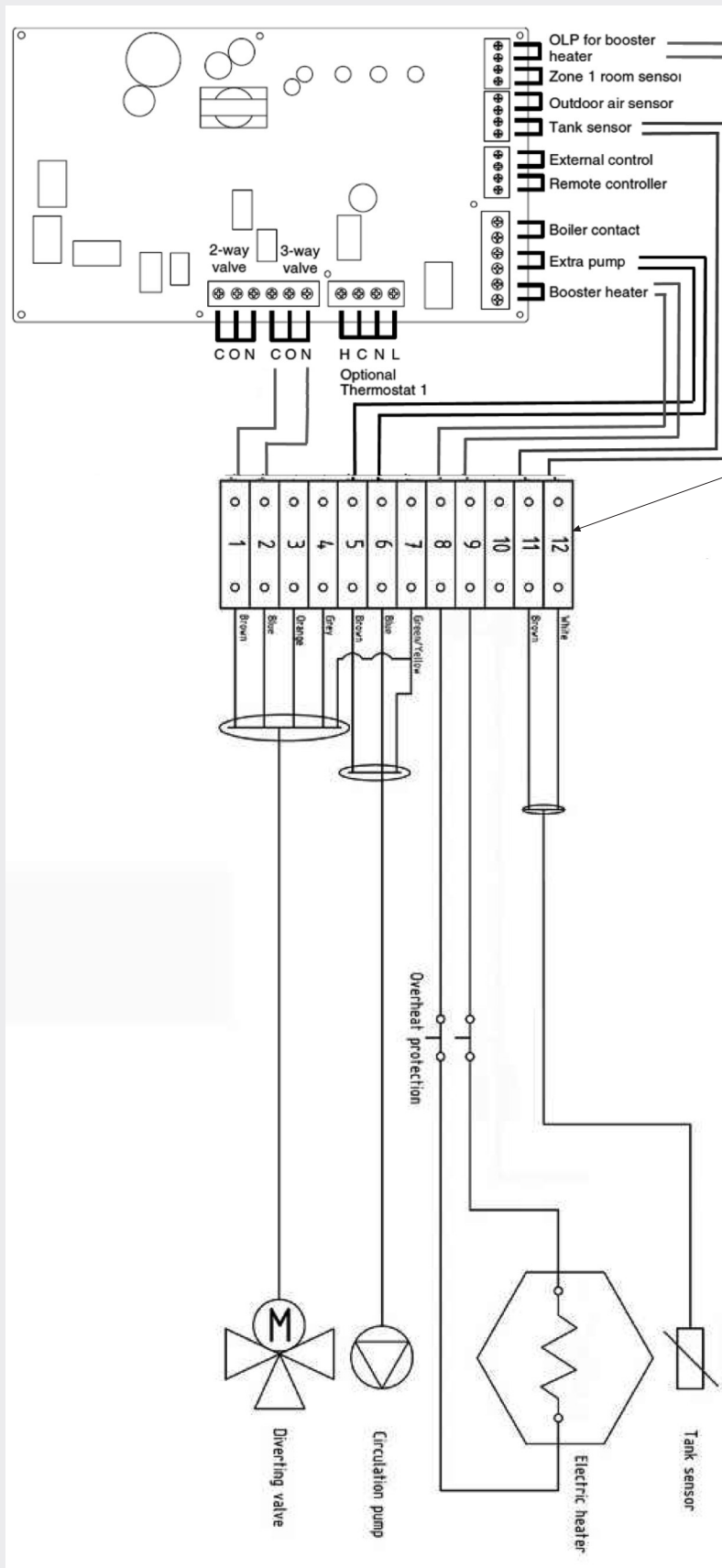

Maintenance

Check manometer 2 times/year

It is particularly important to check the manometer after a new installation. The manometer which shows the pressure within the radiator system should show between 0.5 – 1.2 bar. If needed, fill the system with water until the manometer shows 1.0 bar. If you feel uncertain contact your installer.

Check safety valve 2 times/year

Exercise the safety valve by turning its wheel counter clockwise until water is streaming out of the valve. An overflow pipe shall be mounted that lead water to the nearest floor drain. The reason for this is to secure the function of the valve and that it is not stuck. The temperature variations within the system make the water expand which may lead to water dripping out of the overflow pipe. This is normal.



IMPORTANT!

The overflow pipe of the safety valve may never be blocked!

Cleaning the particle filter 2 times/year (optional)

When the tank has been installed the filter ball valve shall be cleaned once a week the first two weeks. After that the interval is twice a year.

1. Shut the system down via the on/off button on the control panel. Then switch the control fuse off
2. Close the valve by turning the handle (a) 90° upwards and screw off the sealing lid (b).
3. Remove the locking ring (c) using lock ring nippers (e) and pick the filter ball valve out (d). Clean it with water.
4. Assemble it all back in the reverse order.
5. Open the valve to its previous position (the handle to the side).
6. Restart the system by turning the control fuse on and then push the on/off button on the control panel.



Check the protective anode

1. Shut the system down via the on/off button on the control panel. Then switch the control fuse off.
2. Turn off the incoming fresh water to the tank (a).
3. Open a domestic water tap somewhere in the building, to release the pressure within the tank.
4. Remove the anode (b) from its position (at the upper flange) and perform a visual inspection of it.
5. Measure the diameter. If the diameter of the anode is less than 11 mm it shall be replaced.

A anode can be ordered from the installer.

6. Mount the anode back into the tank.
7. Close the domestic water tap.
8. Open incoming fresh water to the tank.
9. Restart the system by turning the control fuse on and then
10. push the on/off button on the control panel.

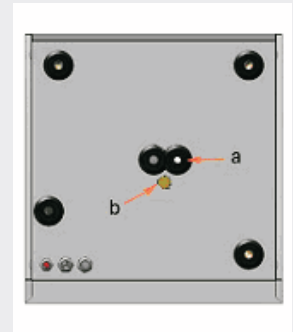

IMPORTANT!









Replace the anode if the diameter is less than 11 mm. The anode protects the tank from aggressive chemical substances in the water.



IMPORTANT!

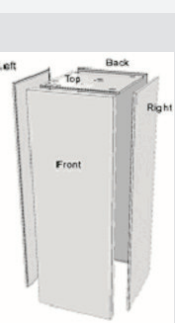

If the power cord is damaged, it must be substituted either by the manufacturer, by its aftersales department or by qualified personnel, in order to avoid any danger.

Spare parts

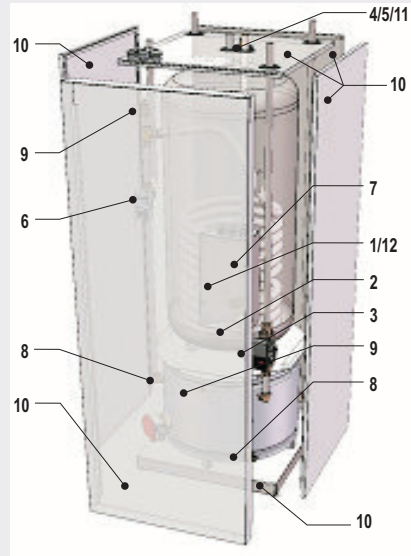
Pos.	Part (picture)	Art-no	Name
1		V001782	Electrical heater 3 kW
2		V001819	Overheat protection
3		V001910	Circulation pump
4		V001943	Anode
5		V001952	Anode (Chain anode)
6		V001777	3way valve
7		V001821	Sensor
8		V001778	Drain valve
9		V001781	Air vent
10		V001775	Cover panels complete kit
		V001886	Front panel
		V001884	Top panel
		V001887	Left panel
		V001887	Right panel
		V001885	Back panel
		V001883	Lower frame
		V001888	Connections plate covers

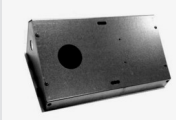

Spare parts

Pos.	Part (picture)	Art-no	Name
11		8430352615980	Upper metal cover kit
		V001922	Metal cover
		G003779	EPDM circular joint
		V001943	Magnesium anode
		V001928	Polypropylene tube
		G000767	Split pin
12		V001774	Electric box
13		8430352616000	Pump gasket kit
14		8430352616017	Three way valve EPDM O-ring kit

Warranty and product liability

For product warranty to apply, the installation must be performed by an authorized technician

(installer / electrician). Connection of plumbing and electronics shall be carried in a safe manner resulting judgment laws and regulations available in the sector. It is very important to following these instructions (including other parts of the heating system) and in carrying out the maintenance provided. By following the installation instructions and design facility in relation to the housing needs, the system takes the premise to operating in many years to come.

In the event of failure of the system, notify your dealer immediately to document the case in accordance with the complaint- and quality routine available.

Make sure that the water quality does not exceed the judgment limits specified in the manual (page 6).

VERY IMPORTANT



"Poor power" for example, from solar cells can damage a steel cylinder in a very short time, if it is passed in through the house's main electricity supply and through the pipeline system.

The Electrician need to verify that you have a "clean current supply" in the house.

Inform the customer of the indoor unit functions. Explain how to maintain the hydro unit

If this mentioned procedures are not followed, the warranty may be voided.



Information for Users on Collection and Disposal of Old Equipment

These symbols on the products, packaging, and/or accompanying documents mean that used electrical and electronic products should not be mixed with general household waste.

For proper treatment, recovery and recycling of old products, please take them to applicable collection points, in accordance with your national legislation and the Directives 2012/19/UE and 2006/66/EC.

By disposing of these products correctly, you will help to save valuable resources and prevent any potential negative effects on human health and the environment which could otherwise arise from inappropriate waste handling. For more information about collection and recycling of old products, please contact your local municipality, your waste disposal service or the point of sale where you purchased the items. Penalties may be applicable for incorrect disposal of this waste, in accordance with national legislation.



For business users in the European Union

If you wish to discard electrical and electronic equipment, please contact your dealer or supplier for further information.

[Information on Disposal in other Countries outside the European Union]

These symbols are only valid in the European Union. If you wish to discard these items, please contact your local authorities or dealer and ask for the correct method of disposal.

Declaration of conformity
The product conforms to the following EU-Directives:
The low voltage directive (LVD) 2014/35/UE
The Pressure Equipment Directive (PED) 2014/68/UE