

Catania C
Art. Nr. 2857101
1/9

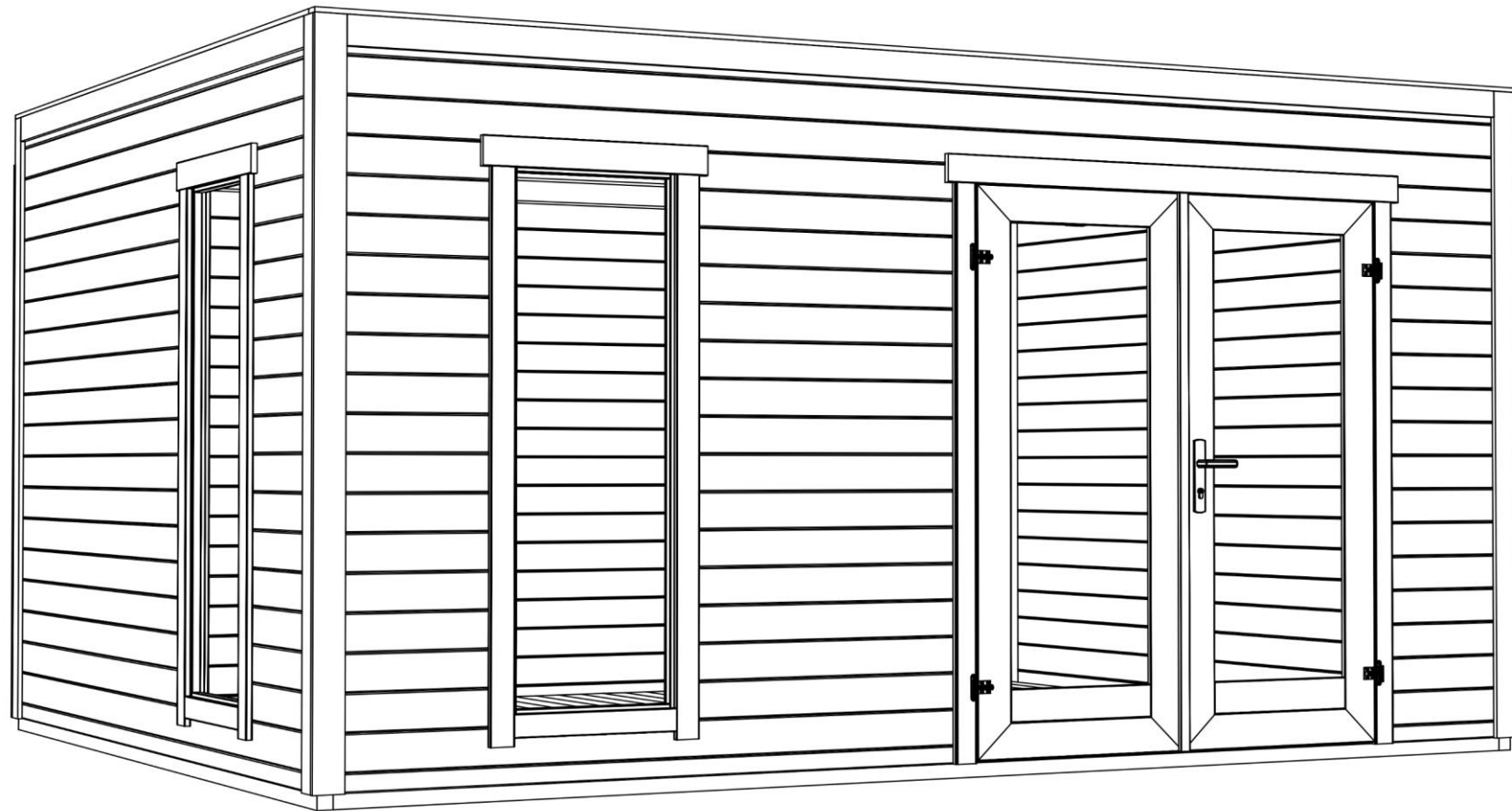

Groundplan - Grundplan - Plan de masse -
Planimetria - Plattegrond - Põhiplaan

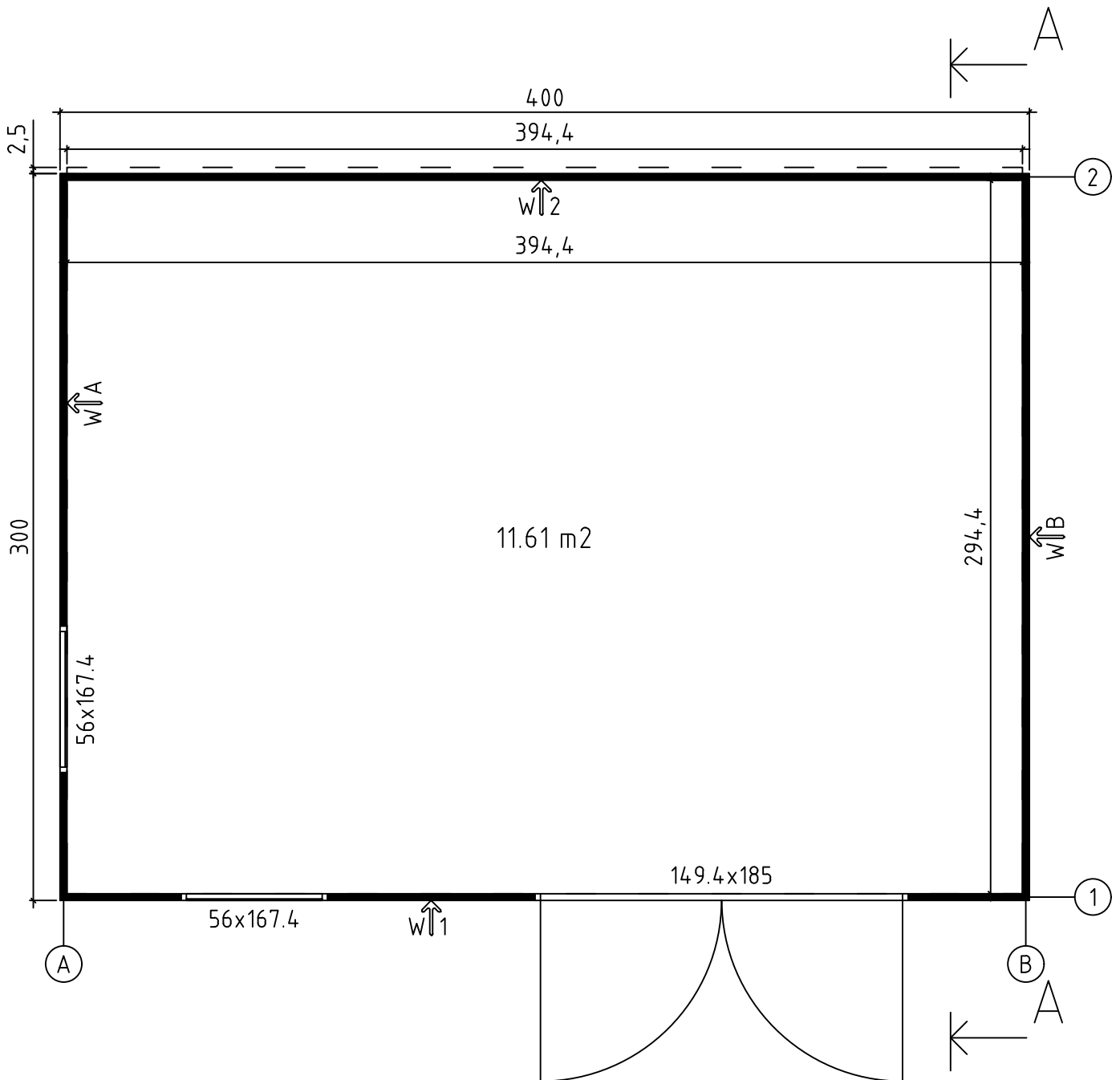

Foundation - Fundament - Fondation -
Fondamenta - Fundering - Immutatud alusraam

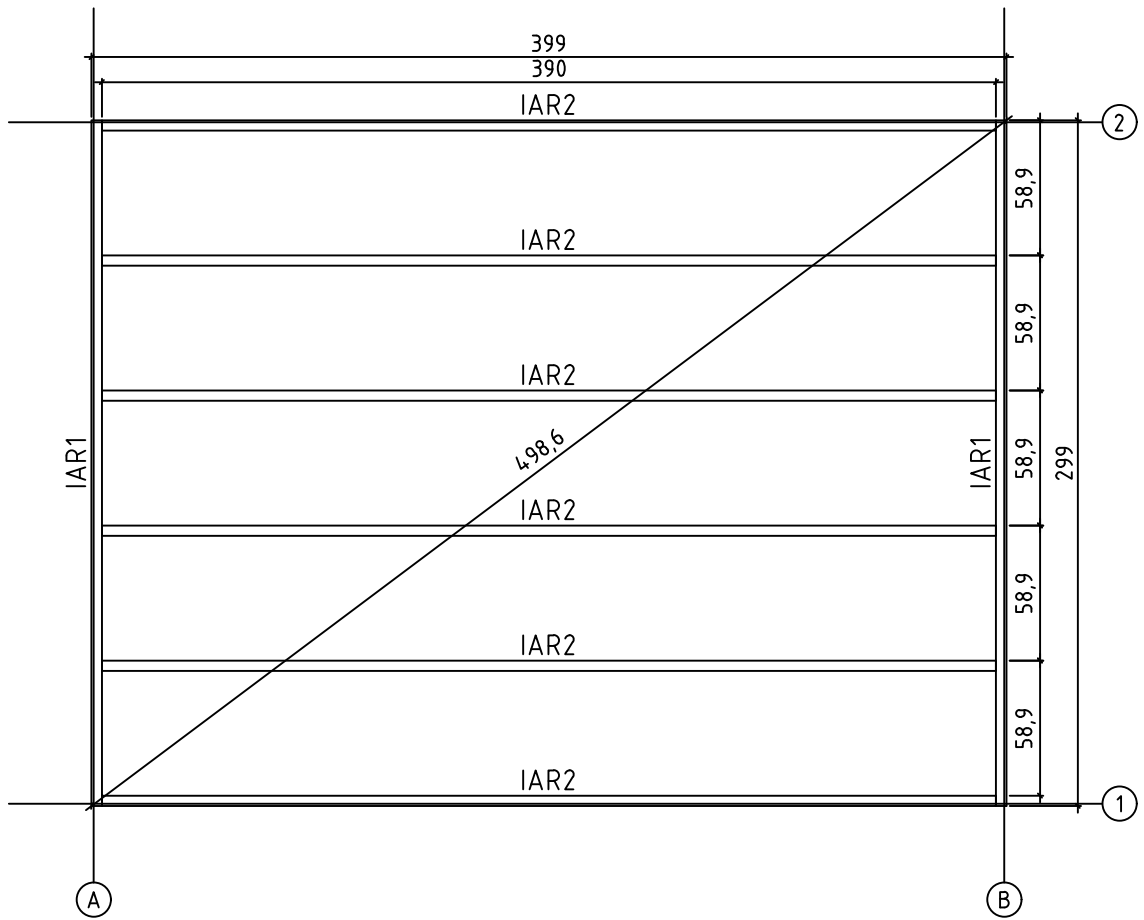

Floor boards - Fussbodenbretter - Plan pose plancher -
Pavimento - Vloerhout - Põrandalaudis

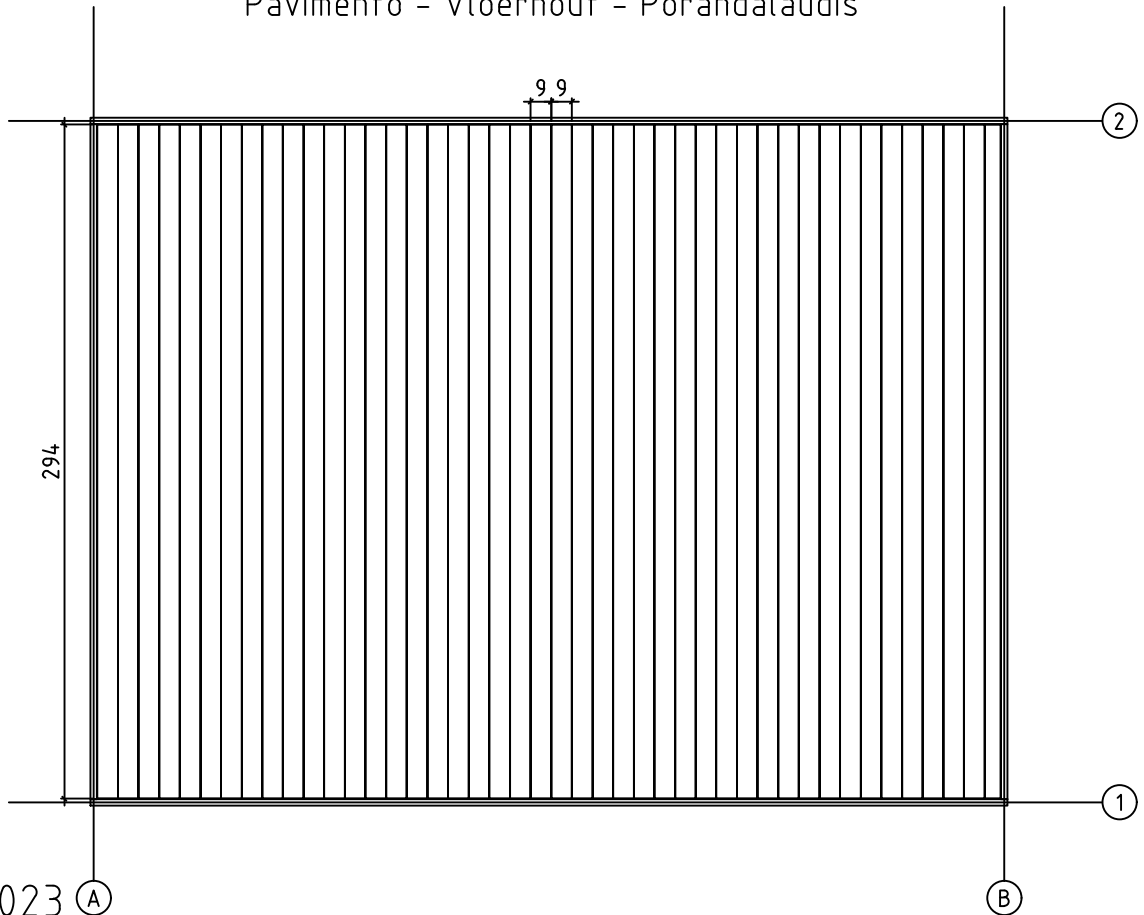

Art. Nr. 2857101

Without tongue - Ohne feder - Madrier de finition -
Finale in legno - Zonder veer - Punnita

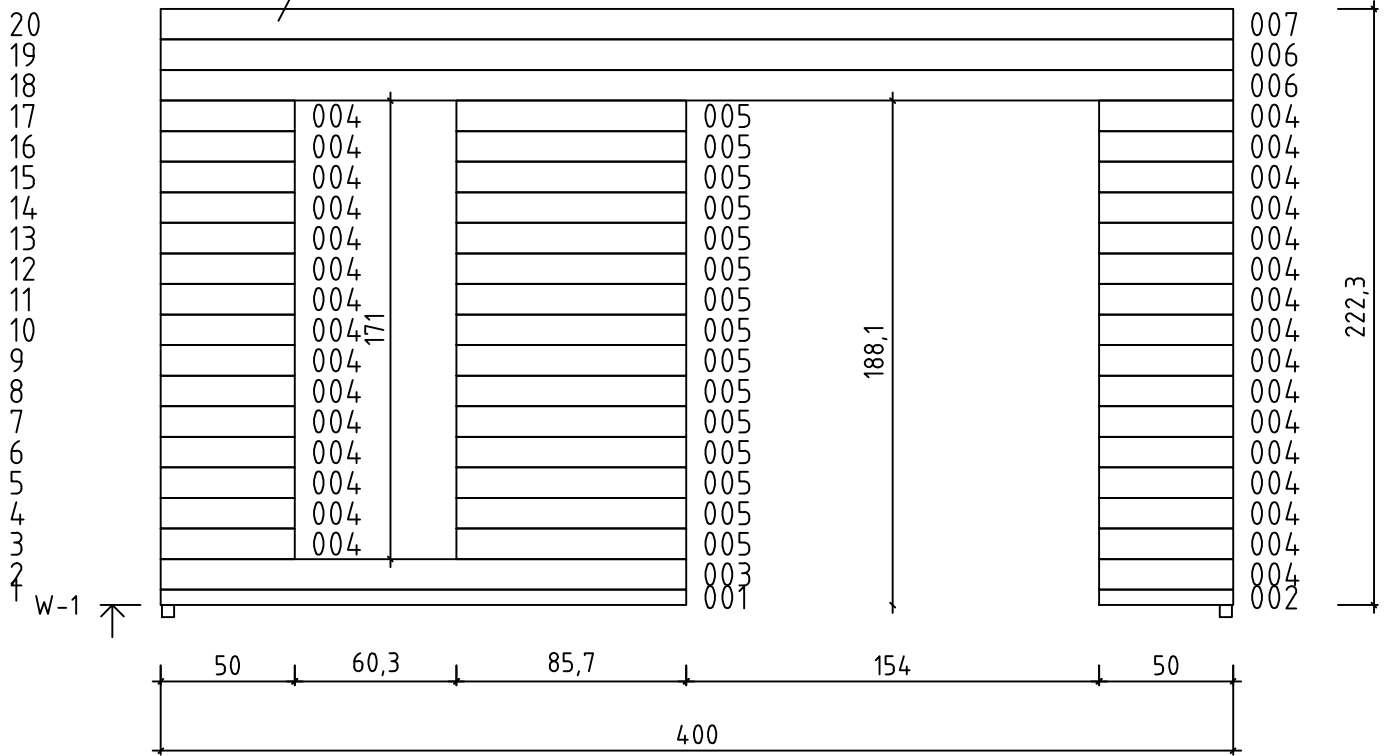



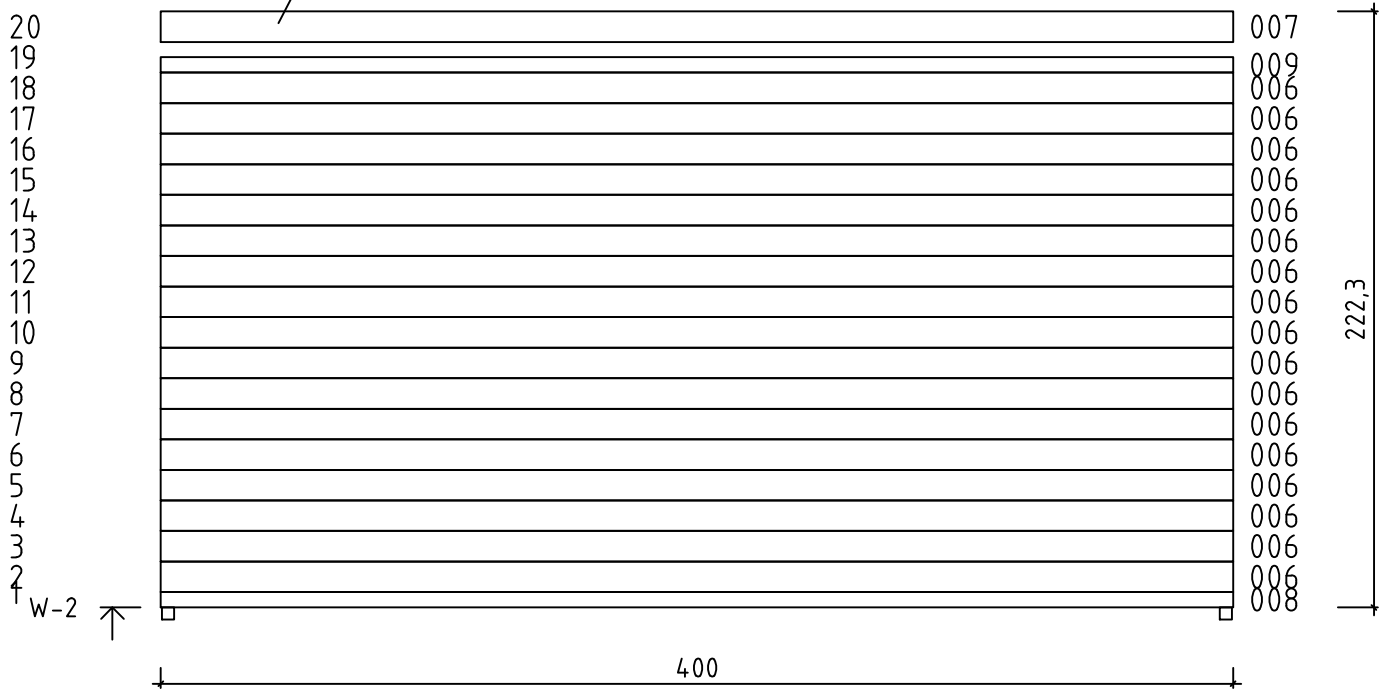



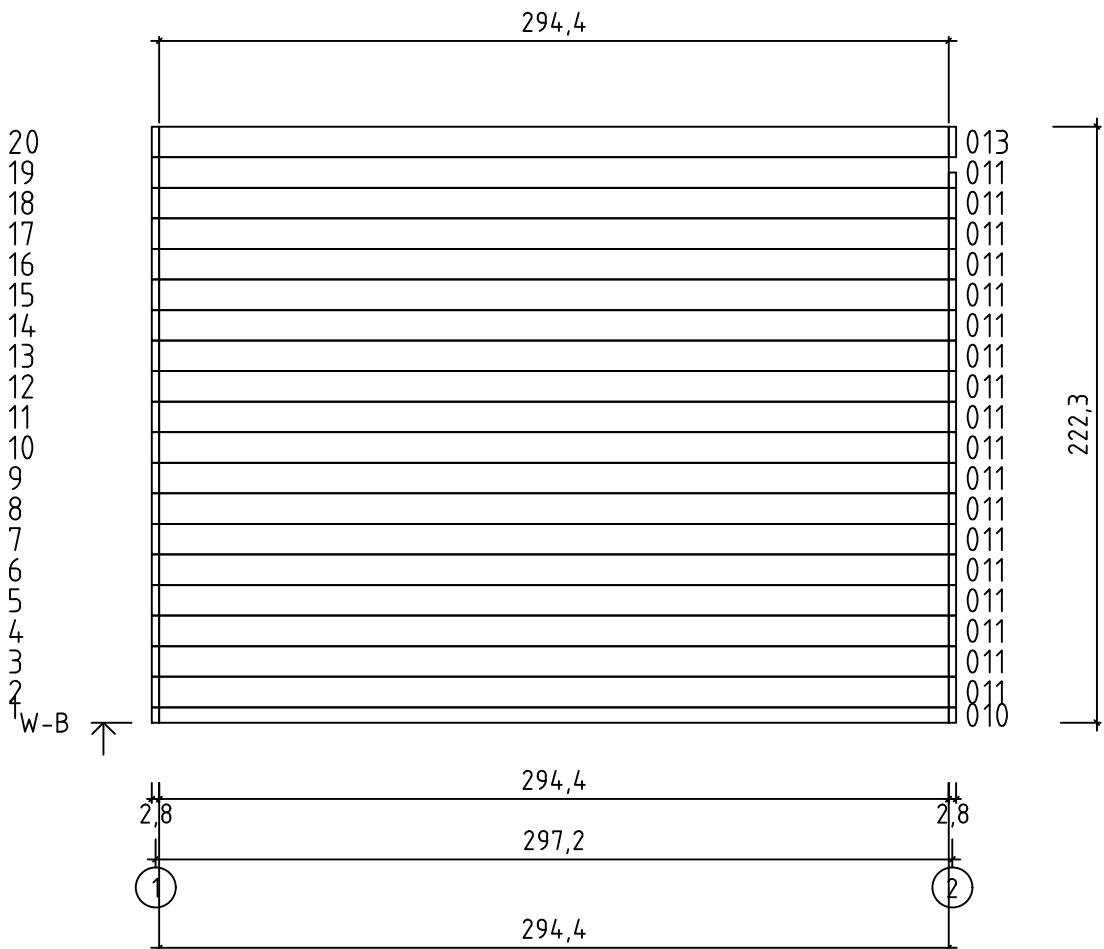
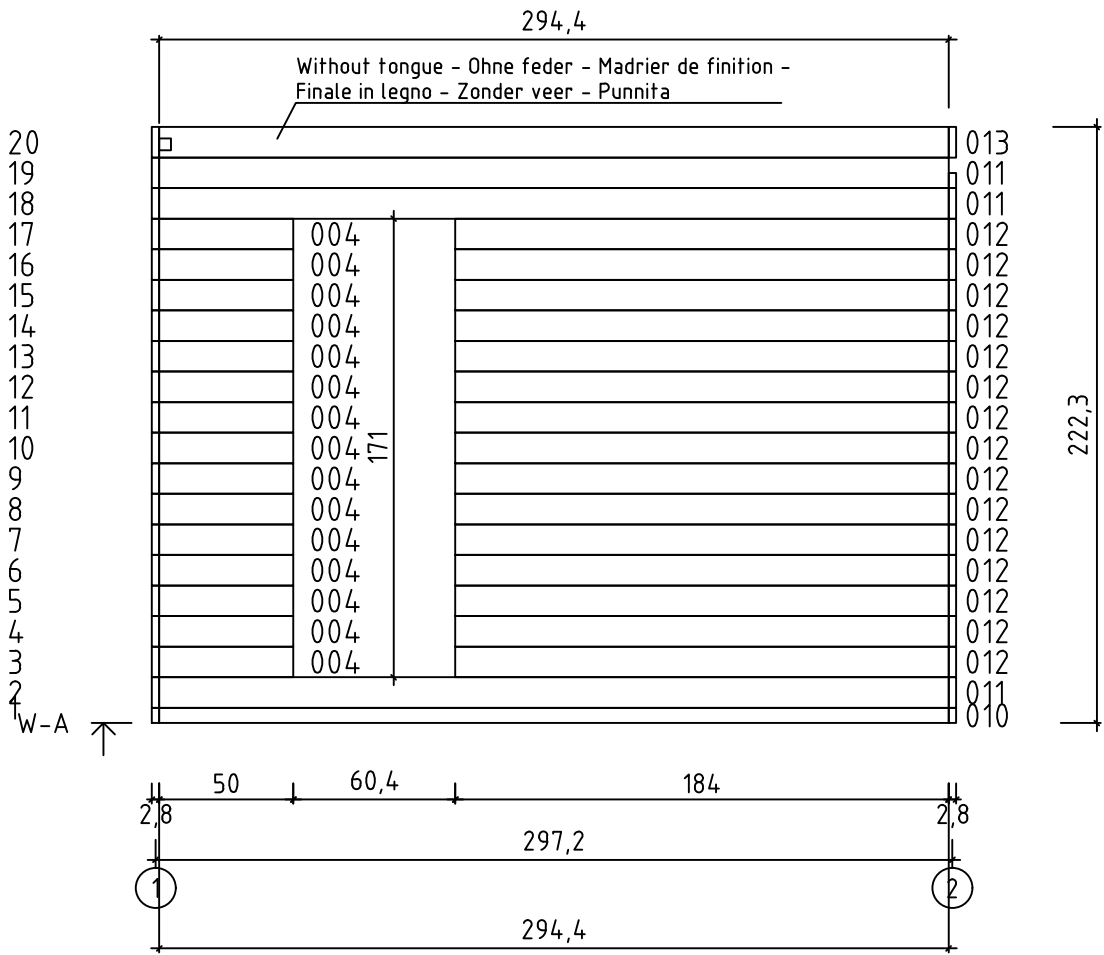

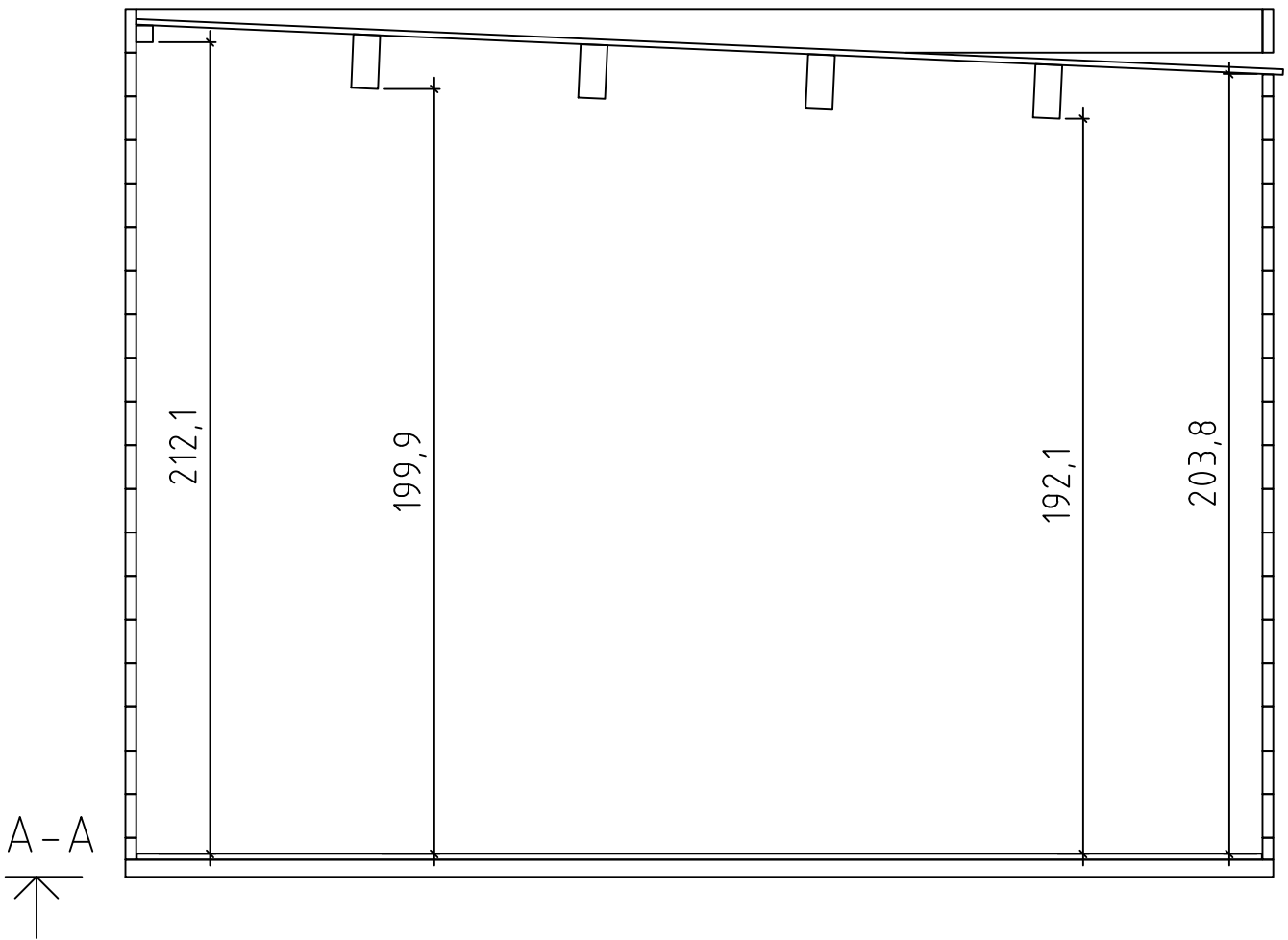

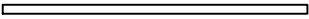

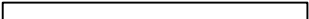

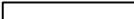

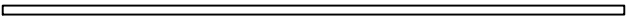
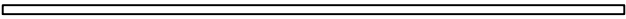
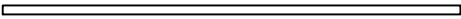
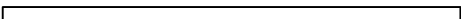
Without tongue - Ohne feder - Madrier de finition -
Finale in legno - Zonder veer - Punnita

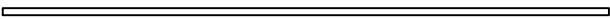
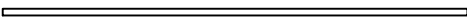









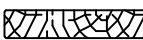
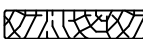

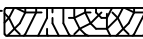
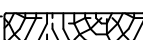

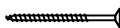
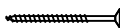
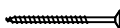
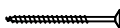

Art. Nr. 2857101

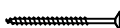

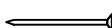

Pos	19.06.2023 Piece list - Stückliste - Liste des pièces - Elementi - Stuklijst - Tükitalabel Art. Nr. 2857101 7/9	Q	P (mm)	L (mm)
001 46330		1	28x57	1960
002 46331		1	28x57	500
003 46332		1	28x114	1960
004 5690		46	28x114	500
005 44378		15	28x114	857
006 946		19	28x114	4000
007 46333		2	28x114	4000
008 46334		1	28x57	4000
009 46335		1	28x57	4000
010 23530		2	28x57	2944
011 18093		21	28x114	2944
012 41073		15	28x114	1840
013 44379		2	28x114	2944
IAR2 16634	Foundation - Fundament - Fondation - Fondamenta - Fundering - Immutatud alusraam 	6	45x45	3900
IAR1 1833	Foundation - Fundament - Fondation - Fondamenta - Fundering - Immutatud alusraam 	2	45x45	2990
RV1 46336	Lath - Pfetten - Linteau - Piccola asse - Gordingen - Roov 	1	44x44	3834
A-PR1 46337	Roof beam - Dachbalken - Panne de toit - Perlina del tetto - Gordingen / dakbalk - Pärilin 	4	70x140	3936
FB 23056	Floor boards - Fussbodenbretter - Lame de plancher - Pavimento - Vloerhout - Põrandalaud 	44	90x15	2940
RB 33576	Roof boards - Dachbretter - Voliges - Perlina per tetto - Dakhout - Katuselaud 	44	90x15	3000
FL-1 30087	Floor fillet - Fussbodenleiste - Corniere de finition du plancher - Finitura per pavimento (battisco pa) - Vloerafwerklijst - Põrandaliist 		18x18	15
RFF1 46308	Roofing felt fillet - Dachpappenleiste - Baguette de fixation du feutre bitumeux - Asse per fissaggio guaina bituminosa - Afdeklijst asfaltpapier - Katusepapiiist 	2	15x45	2970
RFF2 34276	Roofing felt fillet - Dachpappenleiste - Baguette de fixation du feutre bitumeux - Asse per fissaggio guaina bituminosa - Afdeklijst asfaltpapier - Katusepapiiist 	1	15x45	4030
DPP-1	Roofing felt (strip) - Dachpappe (bahnen) - Feutre bitumeux (bande) - Cartone catramato - Asfaltpapier (baan) - Katusepapp 	4		4100

Pos	19.06.2023 Piece list - Stückliste - Liste des pièces - Elementi - Stuklijst - Tükítabel Art. Nr. 2857101 8/9	Q	P (mm)	L (mm)
CF1 41635	Corner fillet - Deckleiste - Profils de finition angles a l'exterieur - Massello d'angolo - (hoek)lijst - Nurgaliist 	4	15x70	2223
CF2 23609	Corner fillet - Deckleiste - Profils de finition angles a l'exterieur - Massello d'angolo - (hoek)lijst - Nurgaliist 	2	15x90	2052
CF3 44711	Corner fillet - Deckleiste - Profils de finition angles a l'exterieur - Massello d'angolo - (hoek)lijst - Nurgaliist 	2	15x90	2223
P1 44712	Post - Pfosten - Poteau - Piede registrabile - Stijl - Post 	2	55x55	2050
P2 44713	Post - Pfosten - Poteau - Piede registrabile - Stijl - Post 	2	55x55	2180
TB1 46310	Fascia board - Traufbrett - Bandeau de toit - Finitura lati tetto - Gevellijst Räästalaud 	2	15x90	2860
TB2 46338	Fascia board - Traufbrett - Bandeau de toit - Finitura lati tetto - Gevellijst Räästalaud 	1	15x90	3850
FF1 46311	Fixing fillet - Fixierungsleiste - Profil de fixation - Massello di fissaggio - Bevestiging lijstwerk - Tenderlijst 	4	18x28	1680
FF2 23522	Fixing fillet - Fixierungsleiste - Profil de fixation - Massello di fissaggio - Bevestiging lijstwerk - Tenderlijst 	2	18x28	1850
HS8 5105	Screw for corner fillet - Schraube zur befestigung deckleiste - Vis pour profils de finition angles a l'exterieur - Viti per massellino d'angolo - Schroef voor afdekljst (hoek) - Kruvi nurgaliistudele 	80	3.5x35	
HS12 5109	Screw for beam holder - Schrauben für balkenhalter - Vis de fixation support "u" galvanisé - Vite per trave di sostegno - Schroef voor bevestiging balkhouder (gordingschoen) - Kruvi talakingale 	48	4x40	
HS12 5109	Screw for fixing fillet of door and window - Schrauben für fixierungsleiste - Vis pour profil vertical de fixation pour ouvertures des fenetres et portes - Viti per massello di fissaggio - Schroeven voor bevestiging van deur en raam lijsten - Kruvi tenderlijstudele 	94	4x40	
HS13 5110	Screw for wall details - Schraube für wand details - Vis pour mur details - Viti per elementi della porta - Schroef voor wand details - Kruvi seinadetailile 	320	4x60	
HS27 32038	Screw for roof lath - Schraube für dachlatte - Vis pour latte - Vite per listello del tetto - Schroef voor daklat - Kruvi roovile 	8	5x70	
HS16 5115	Screw for 1. wall beam - Schraube für 1. bohlenreihe - Vis de fixations 1ere rangée de madriers avec poutrelles de fondations - Vite fissaggio alle fondamenta - Schroef voor 1 wandbalk - Kruvi poollauale 	16	5x90	
HS16 5115	Screw for foundation - Schrauben zur befestigung fundament - Vis de fixations des poutrelles de fondations - Viti x fondamenta - Schroef voor fundering - Kruvi alusraamile 	12	5x90	
HS23 5121	Screw for wall details - Schraube für wand details - Vis pour mur details - Viti per elementi della porta - Schroef voor wand details - Kruvi seinadetailidele 	25	6x180	
HS29 44767	Screw for beam holder - Schrauben für balkenhalter - Vis de fixation support "u" galvanisé - Vite per trave di sostegno - Schroef voor bevestiging balkhouder (gordingschoen) - Kruvi talakingale 	64	5x25	
NF2 5127	Zn nail for floor fillet - Zn nägel für fussbodenleiste - Pointe pour corniere de finition du plancher - Chiodi x fissaggio pavimento - Spijker(nagel) voor vloer afdekljst - Nael põrandaliistule 	30	1.4x40	
NF4 5137	Zn nail for roof - Zn nägel für dachbretter - Pointe pour fixation voliges de toit - Chiodi x perline tetto - Spijker(nagel) voor dakhout - Nael katuselauale 	270	2x50	
NF4 5137	Zn nail for floor - Zn nägel für fussbodenbretter - Clous pour plancher - Chiodi x perline pavimento - Spijker(nagel) voor vloer - Nael põrandalauale 	270	2x50	
NF5 5145	Zn nail for roofing felt fillet - Zn nägel für dachpappenleiste - Pointe pour baguette de fixation feutre bitumeux - Chiodi x carta bituminosa x tetto - Spijker(nagel) voor asfaltpapier afdekljst - Papiliistunael 	18	2x40	
NF6 21567	Roofing nails for roofing felt - Nägel für dachpappe - Pointe pour fixation feutre bitumeux - Chiodi per cartone catramato - Asphalt-nagel - Papinael 	140	2.8x15	

Pos

06.05.2023 Piece list - Stückliste - Liste des pièces - Elementi - Stuklijst - Tükitabel
560x1674 AK.1.100.SM0.q SGC 1/1

Q

P
(mm)

L
(mm)

Glass size - Glasgröße - Taille de la vitre - Misura del vetro - Glas afmeting - Klaasi mõõt: 480x1594 mm

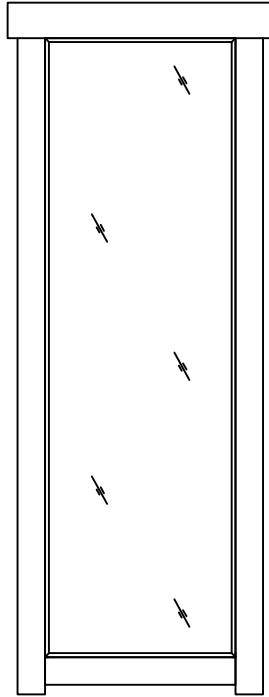

Pos	07.06.2023	Piece list - Stückliste - Liste des pièces - Elementi - Stuklijst - Tükitabel 1494x1850 TUK.1.100.SVP.MX28 SGA+28	1/2	Q	P (mm)	L (mm)
-----	------------	--	-----	---	-----------	-----------

Glass size - Glasgröße - Taille de la vitre - Misura del vetro - Glas afmeting - Klaasi mõõt: 502x1492 mm

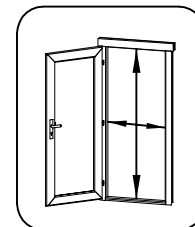

1418x1792

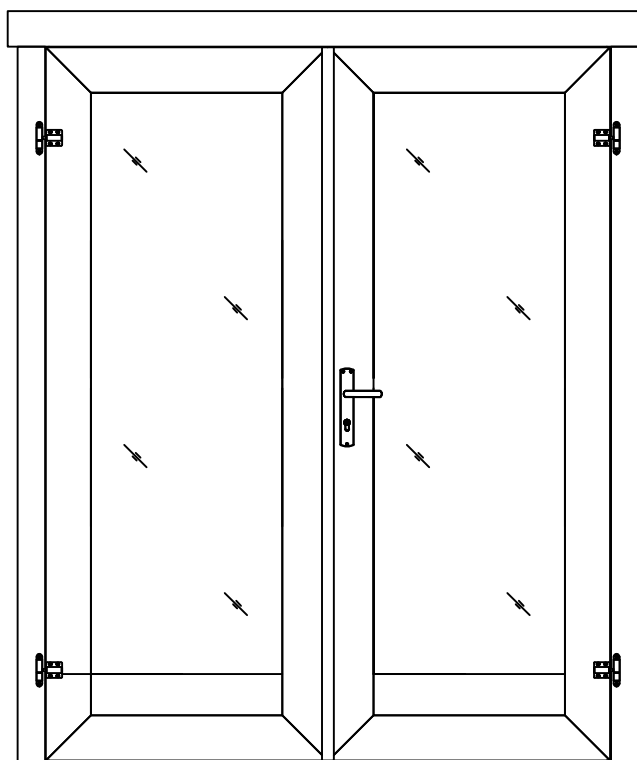

1	Upper door jamb - Türrahmen oben - Cadre de porte supérieur - Telaio superiore della porta - Bovendorpel - Ukse ülemine leng		1	66x100	1438
2	Left door jamb - Türrahmen links - Cadre de porte gauche - Telaio montante sinistro della porta - Linkerstijl deurframe - Ukse vasak leng		1	66x80	1850
3	Right door jamb - Türrahmen rechts - Cadre de porte droit - Telaio montante destro della porta - Rechterstijl deurframe - Ukse parem leng		1	66x80	1850
4	Doorstep - Swelle - Barre de seuil - Soglia della porta - Deurdorpel - Lävepak		1	18x18	1418
5	Connection strip - Deckleiste - Baguette de battement - Profilo verticale della porta - Stulplijst - kokkuvaltssiliist		1	13x30	1812

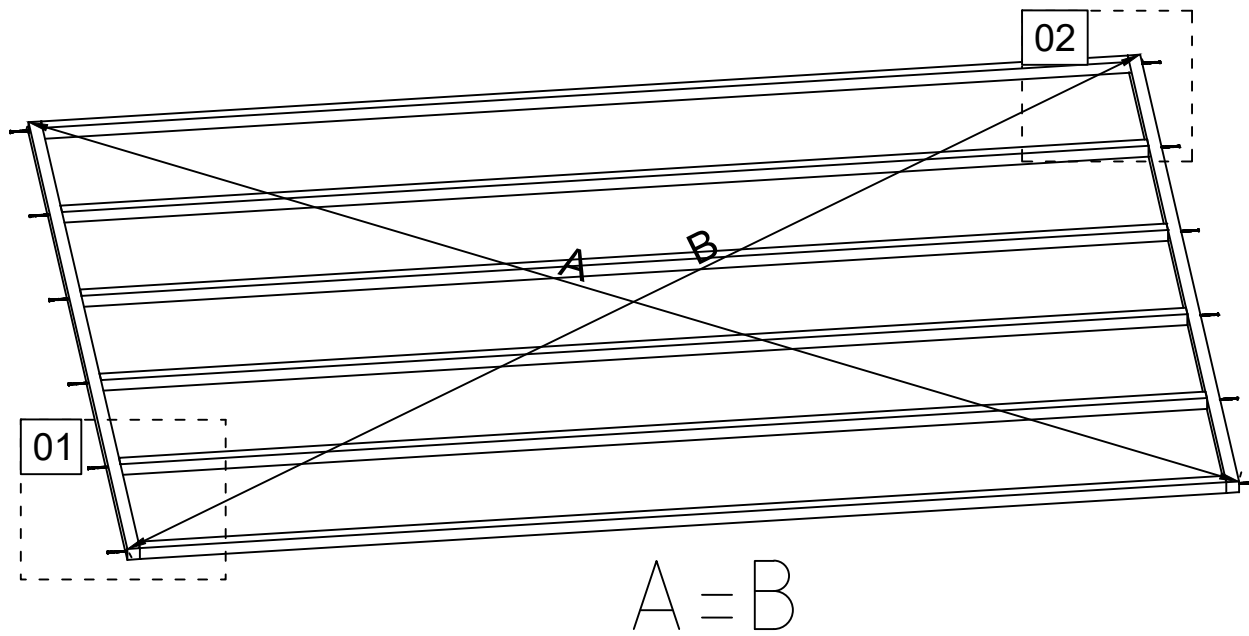

01

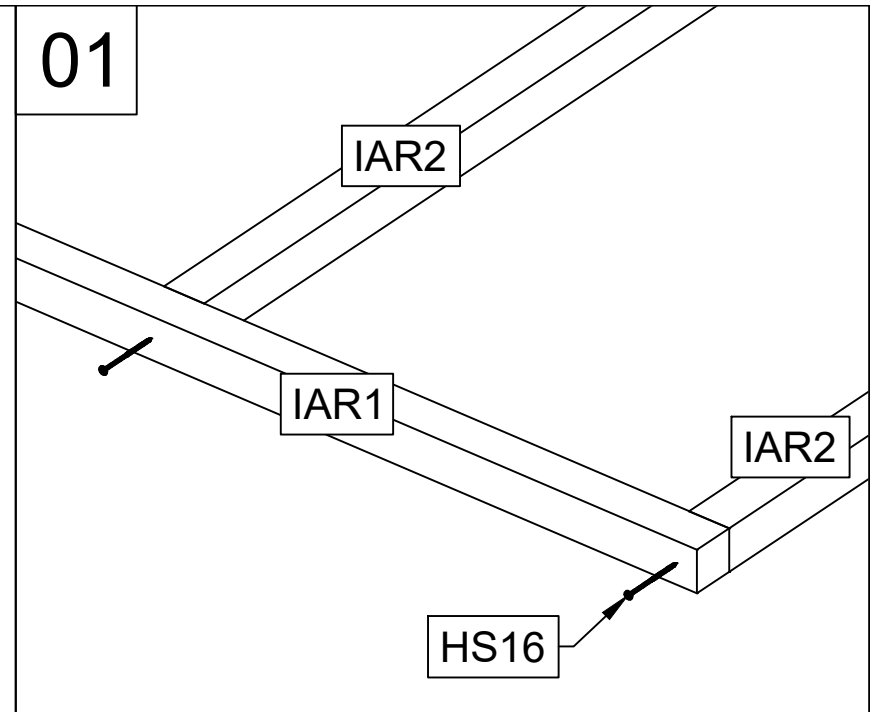

02

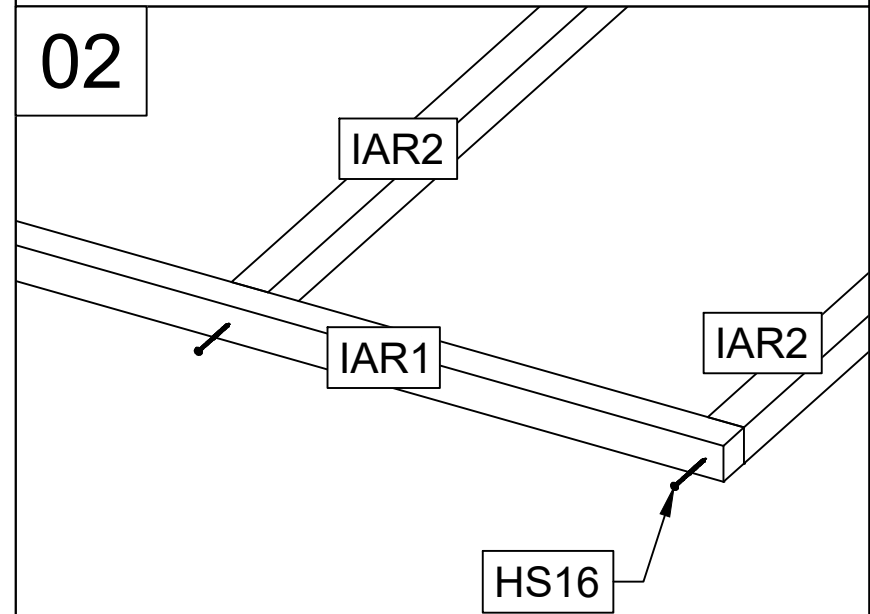

Art. Nr. 2857101

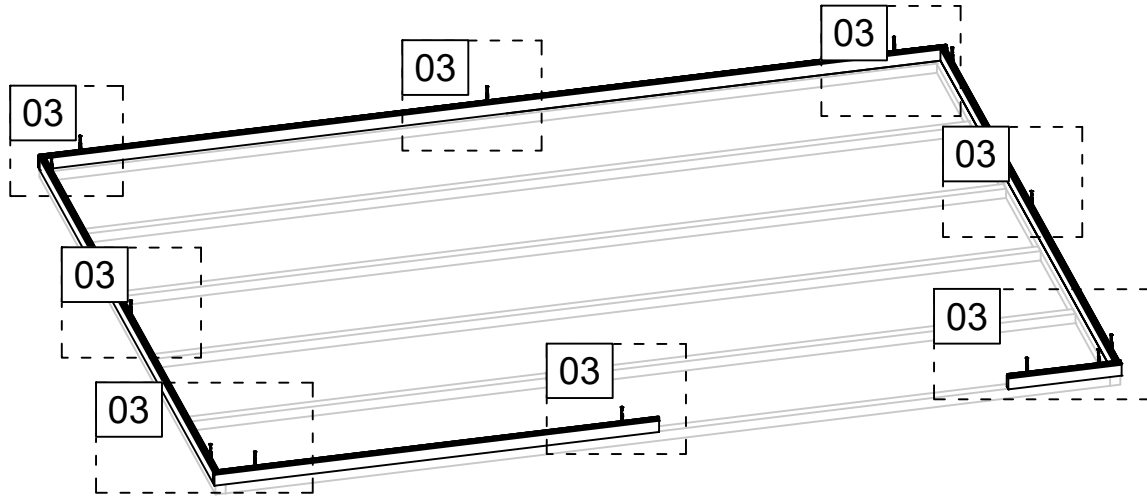

03

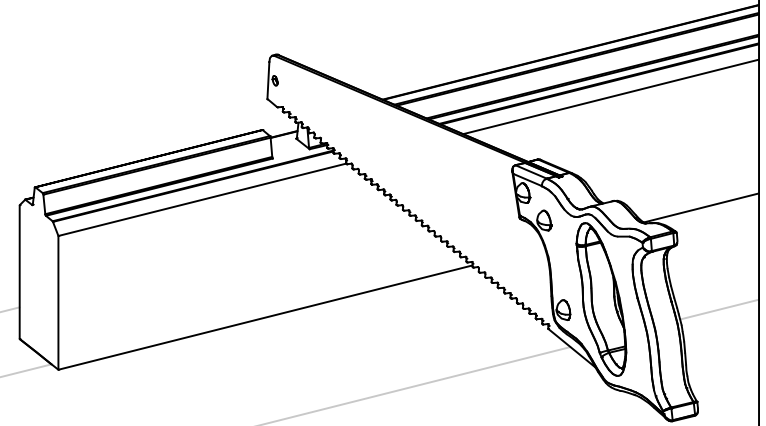

03

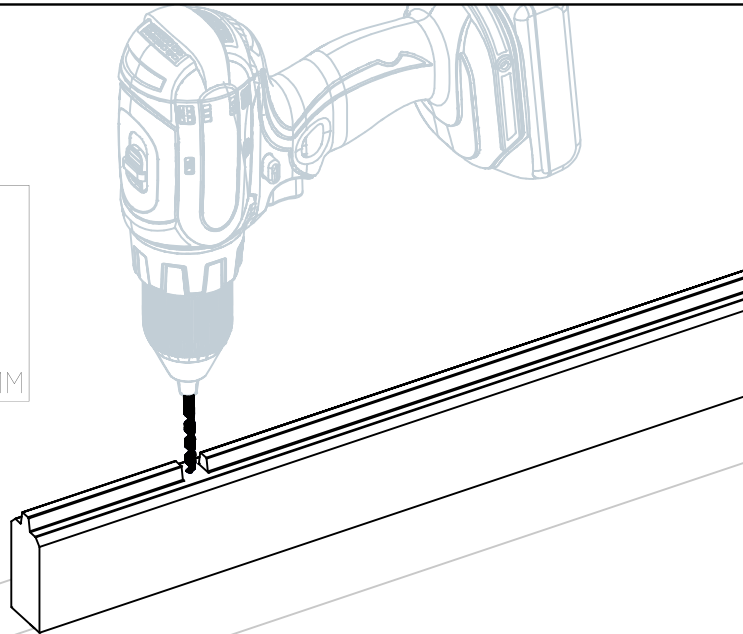
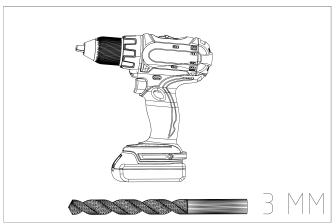

03

HS16

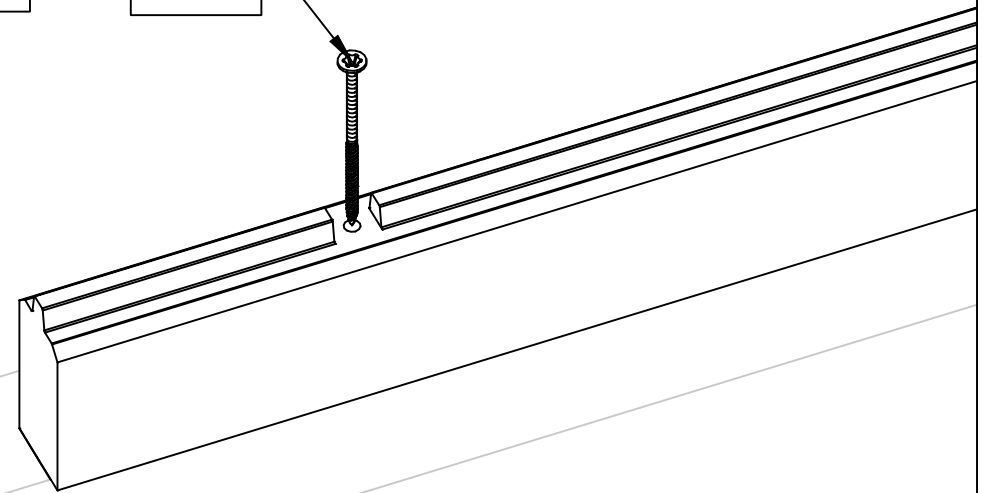

Art. Nr. 2857101

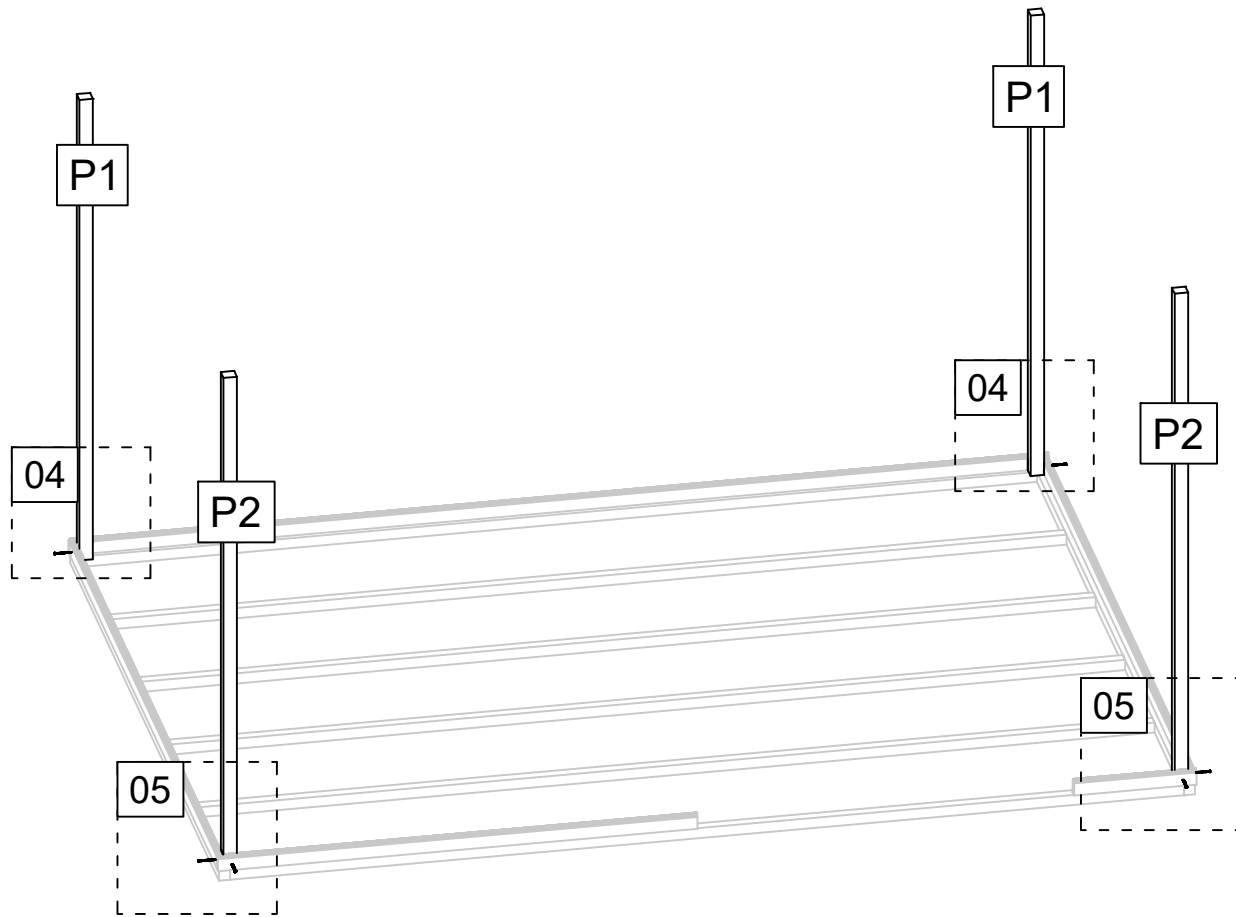

04

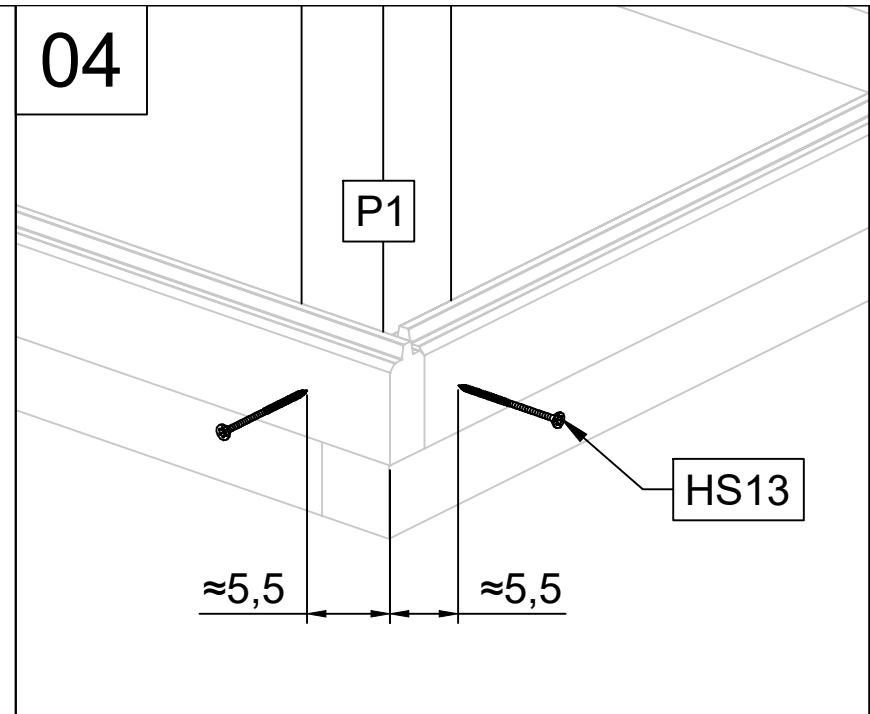

05

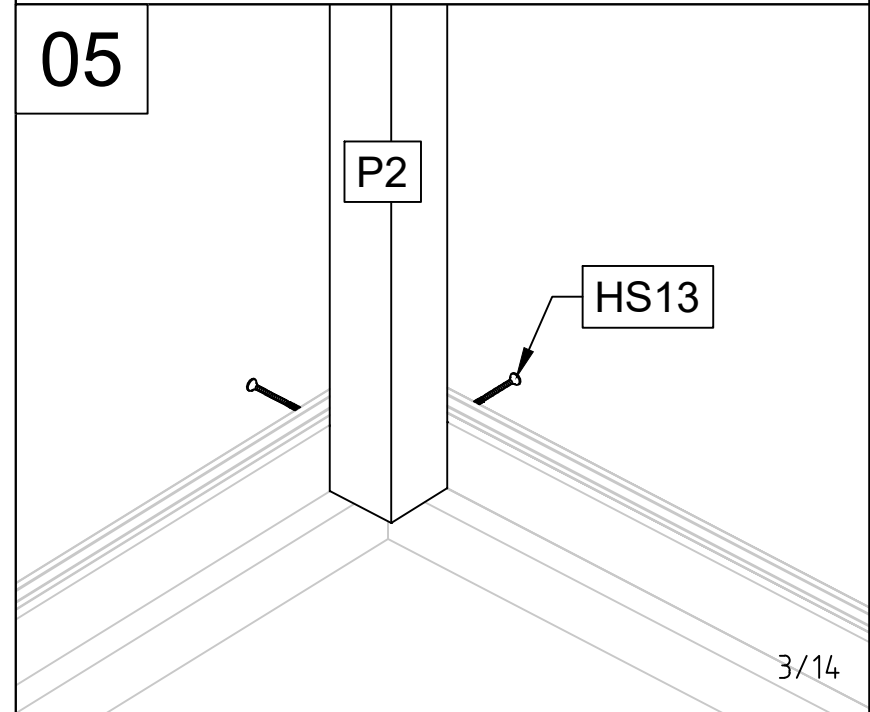

Art. Nr. 2857101

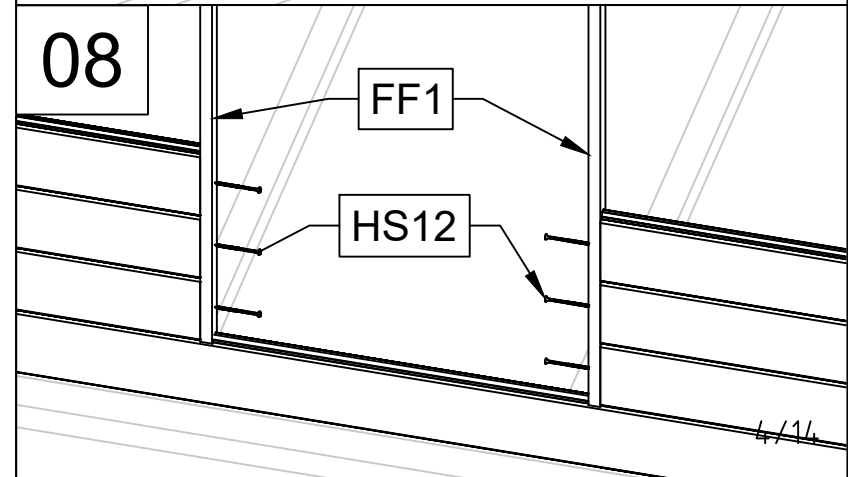
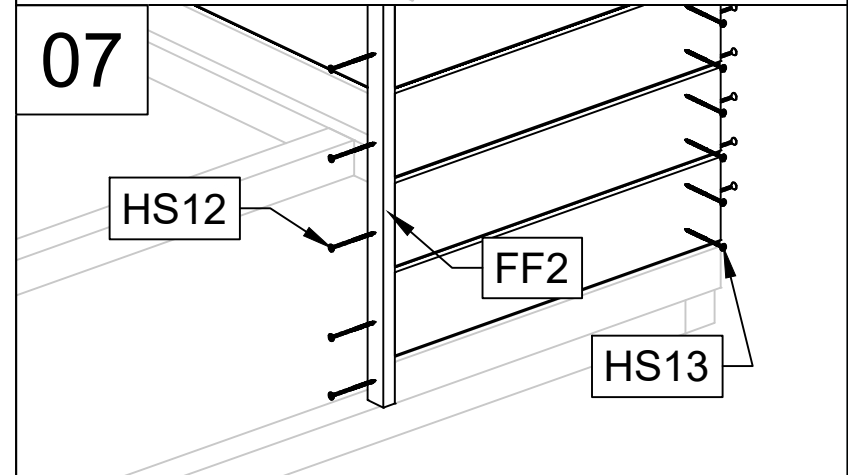
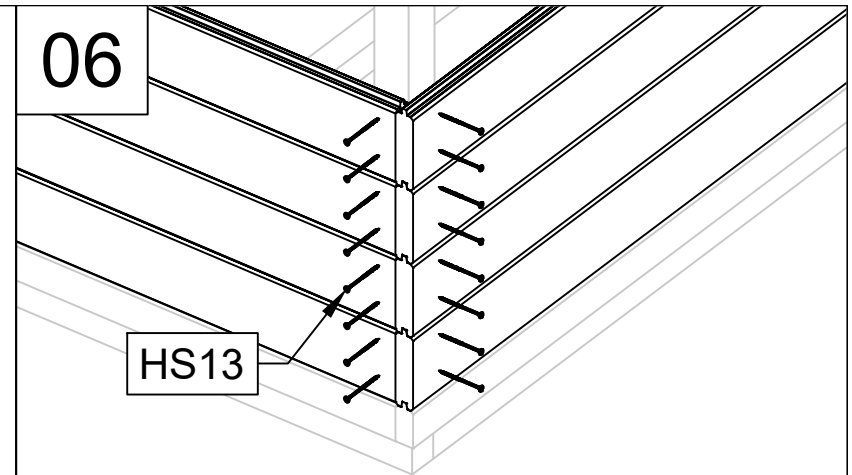
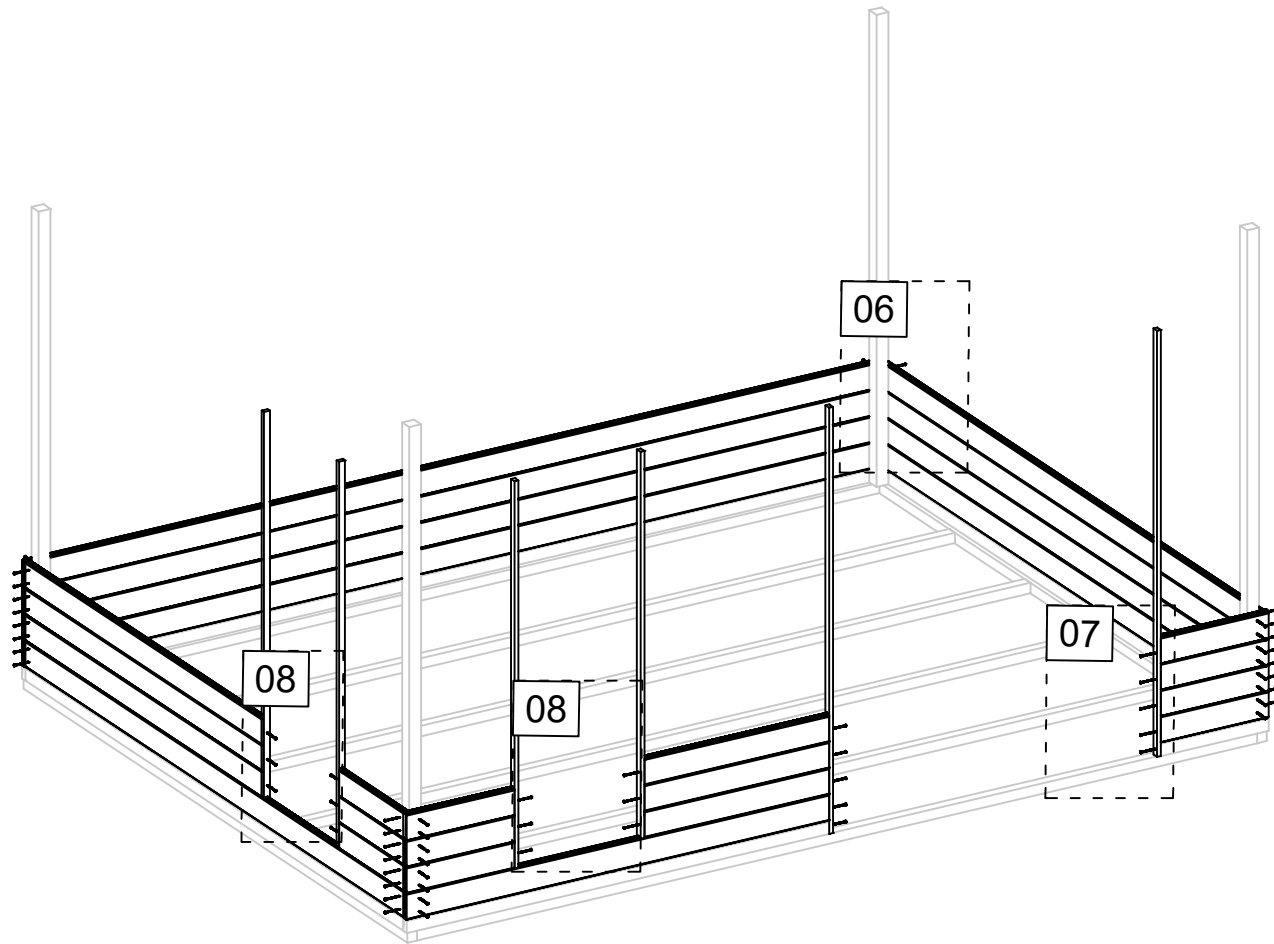

Art. Nr. 2857101

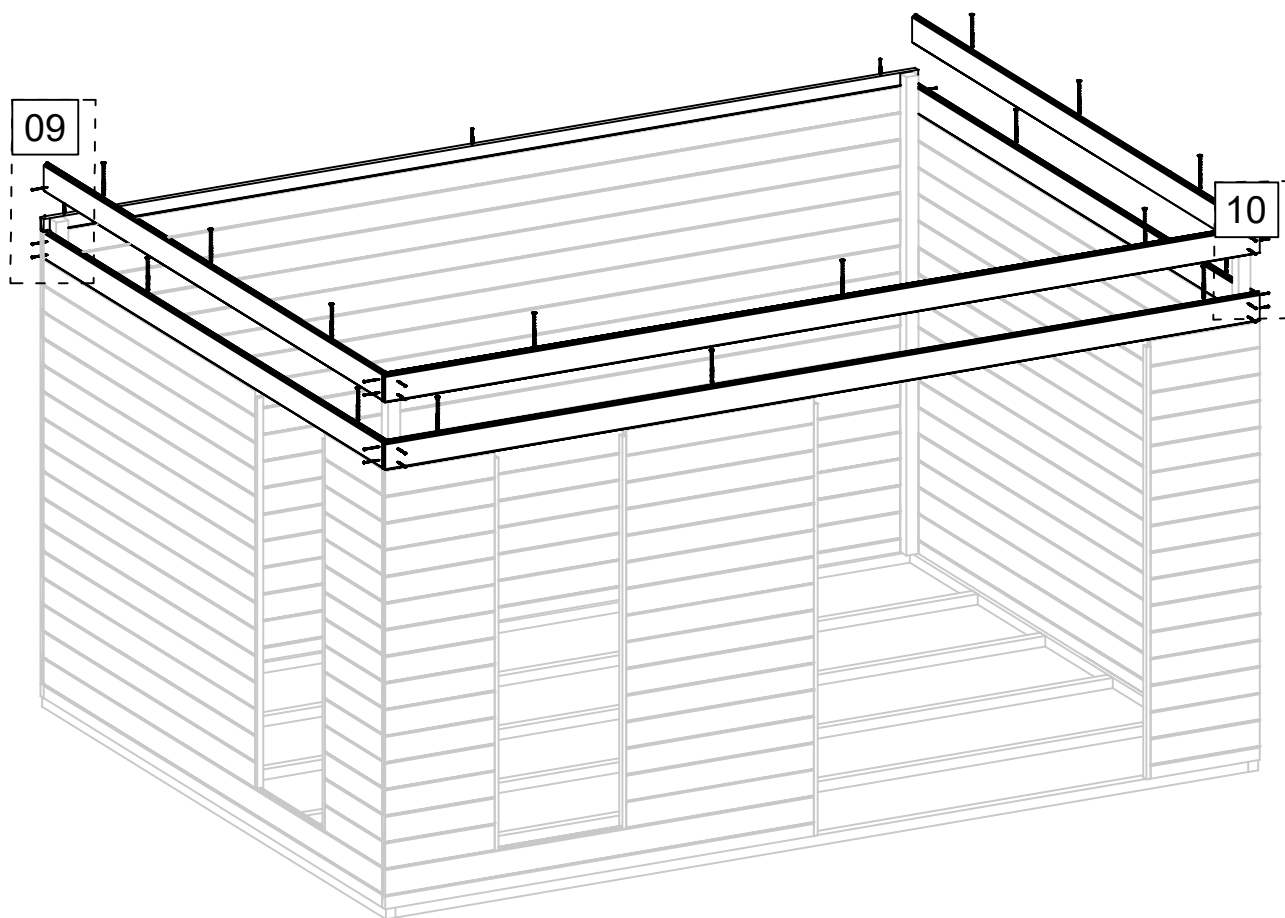

09

HS16

HS13

HS13

10

HS13

11

Art. Nr. 2857101

11

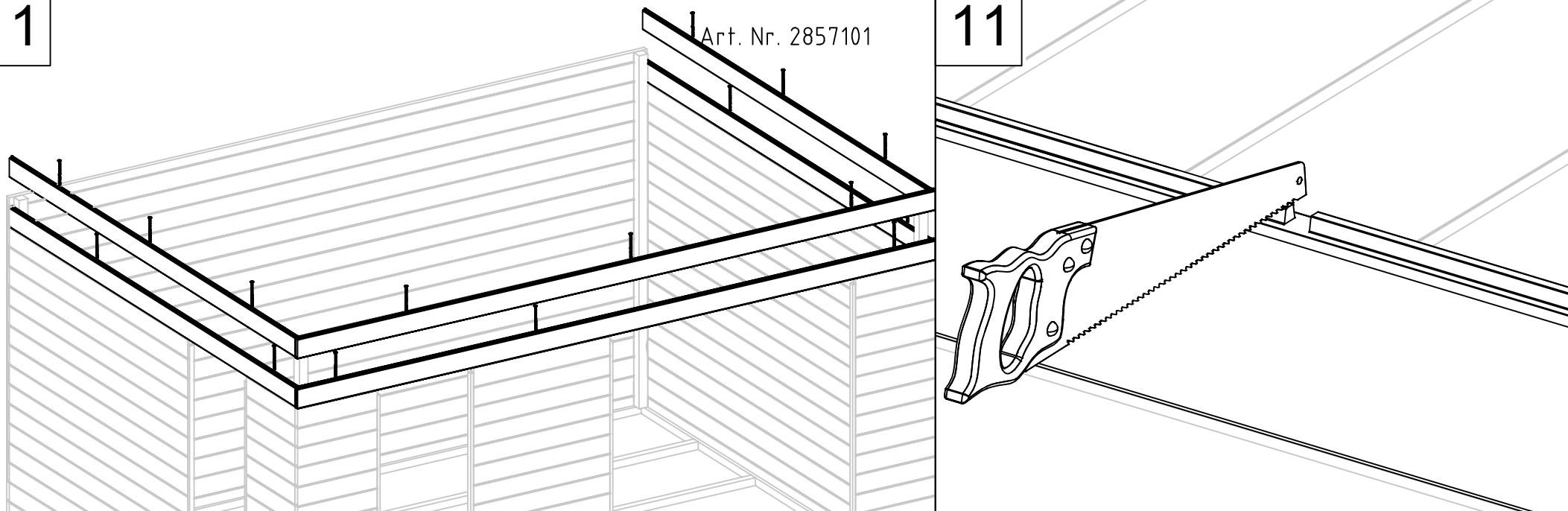

11

11

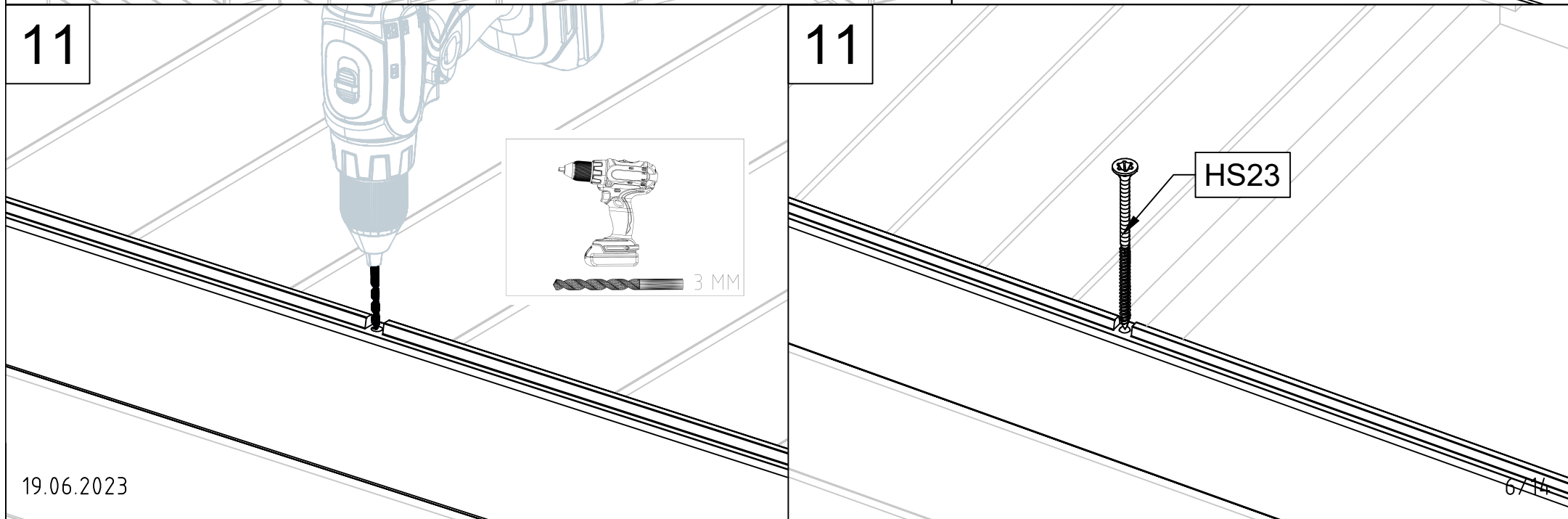

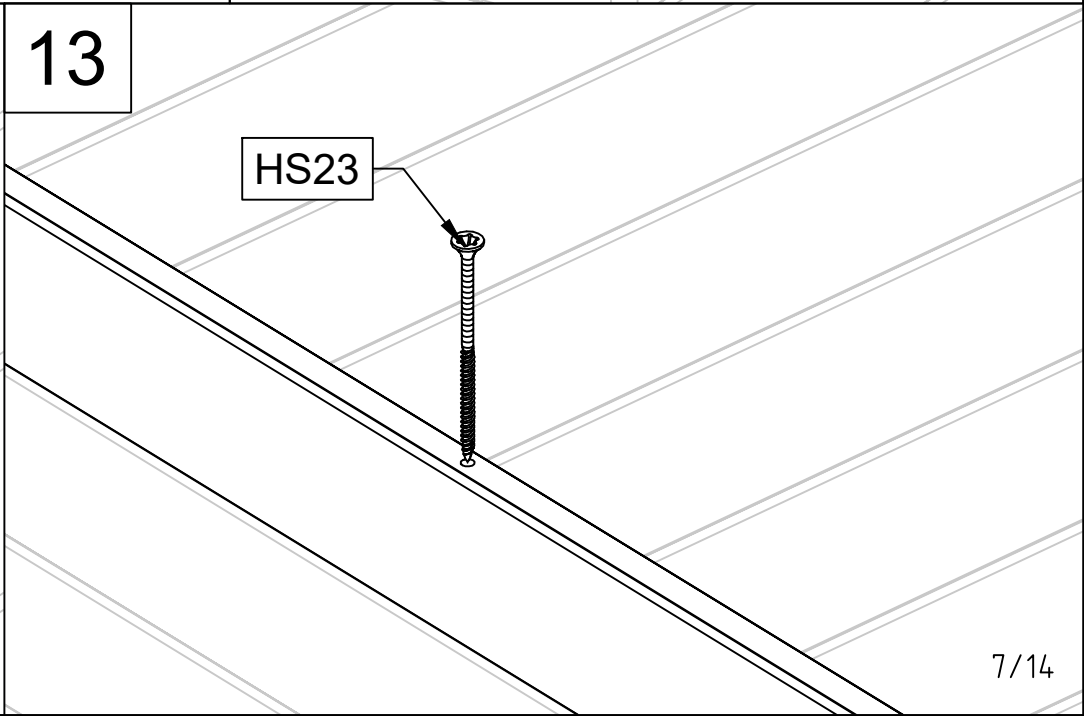
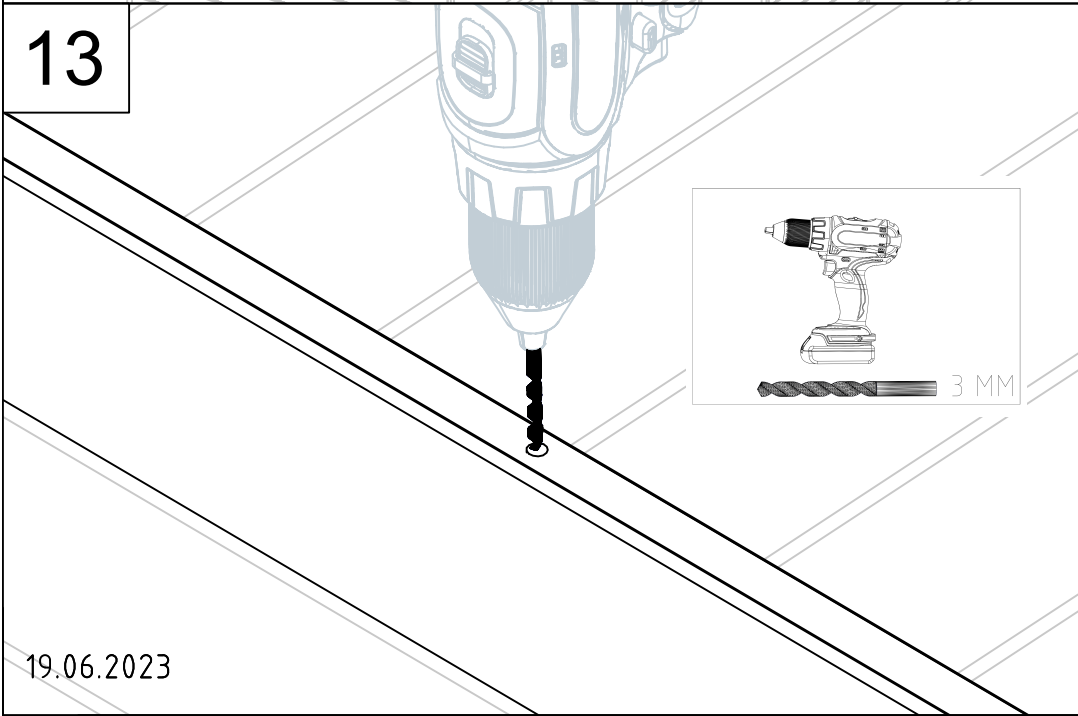
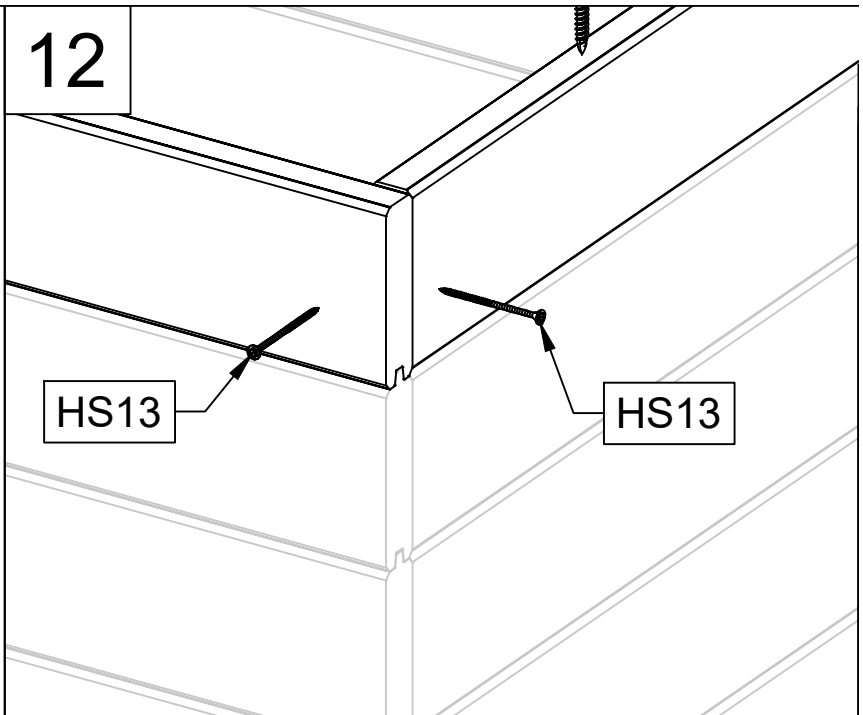
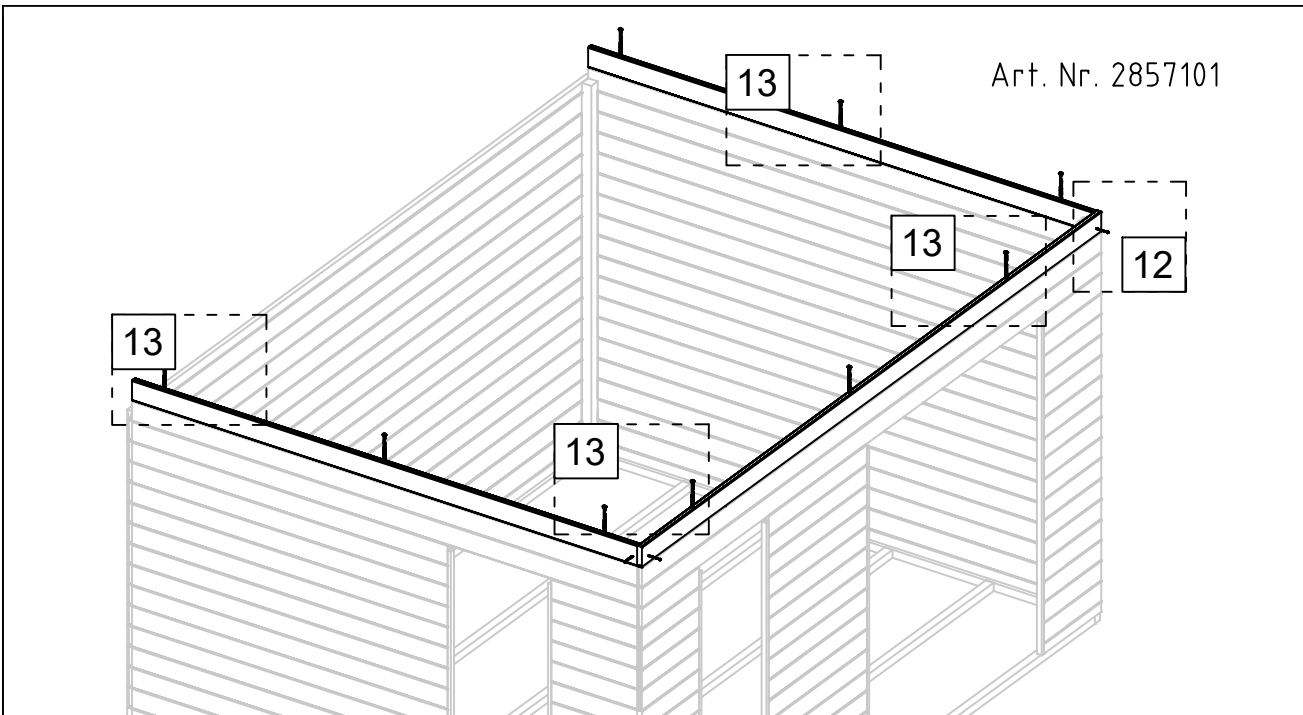

Art. Nr. 2857101

14

14

RV1

HS27

19.06.2023

8/14

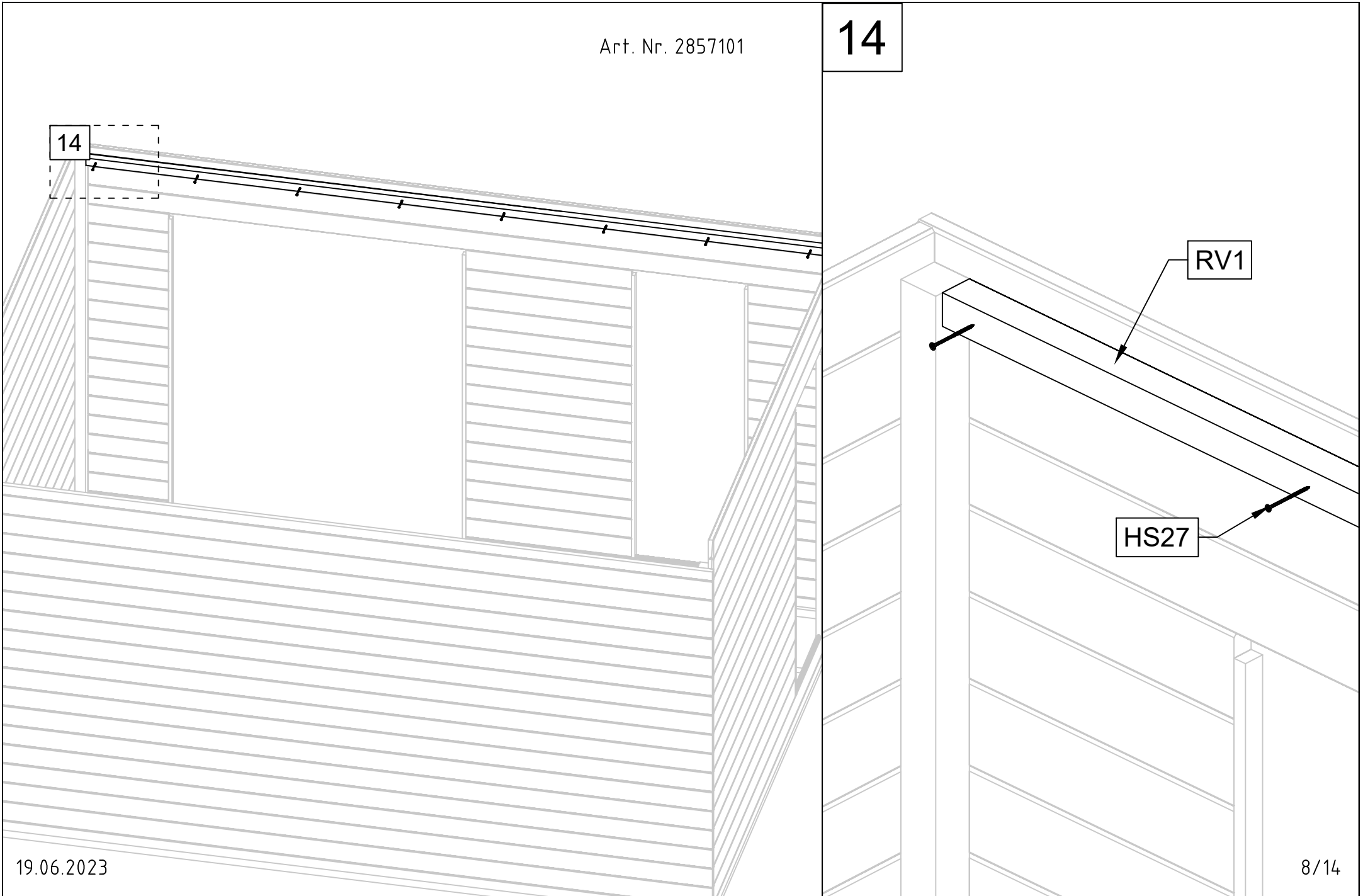

Art. Nr. 2857101

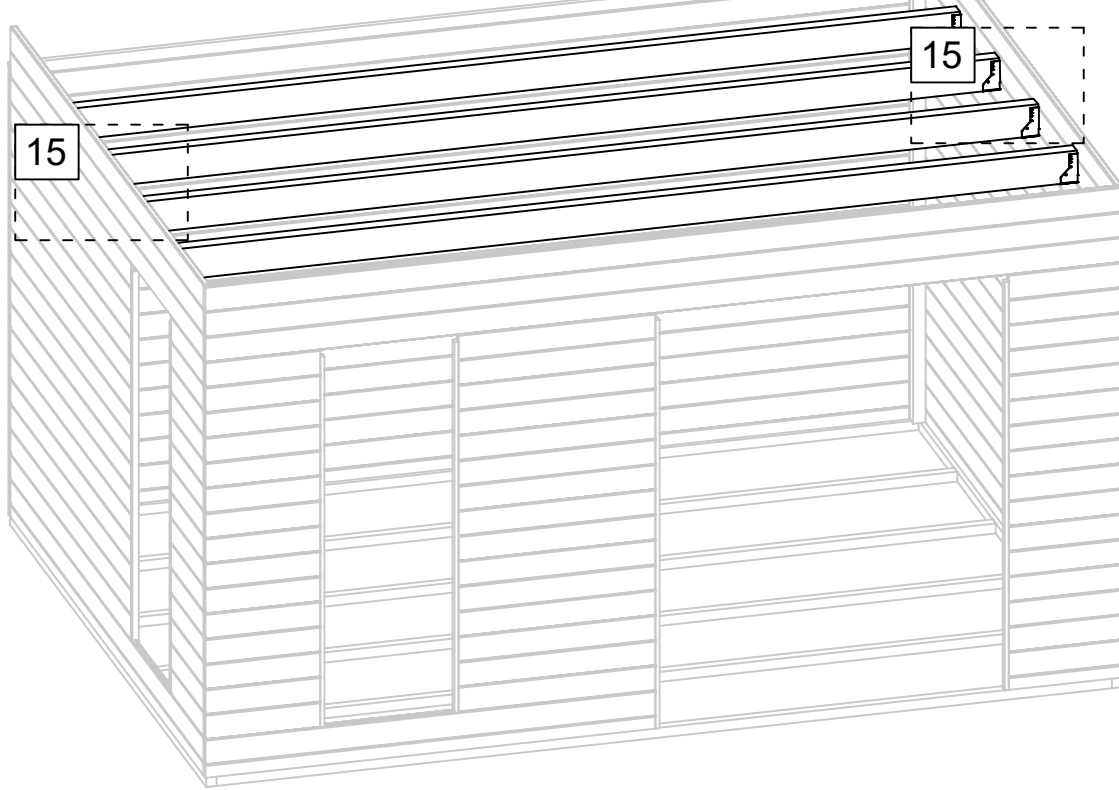

15

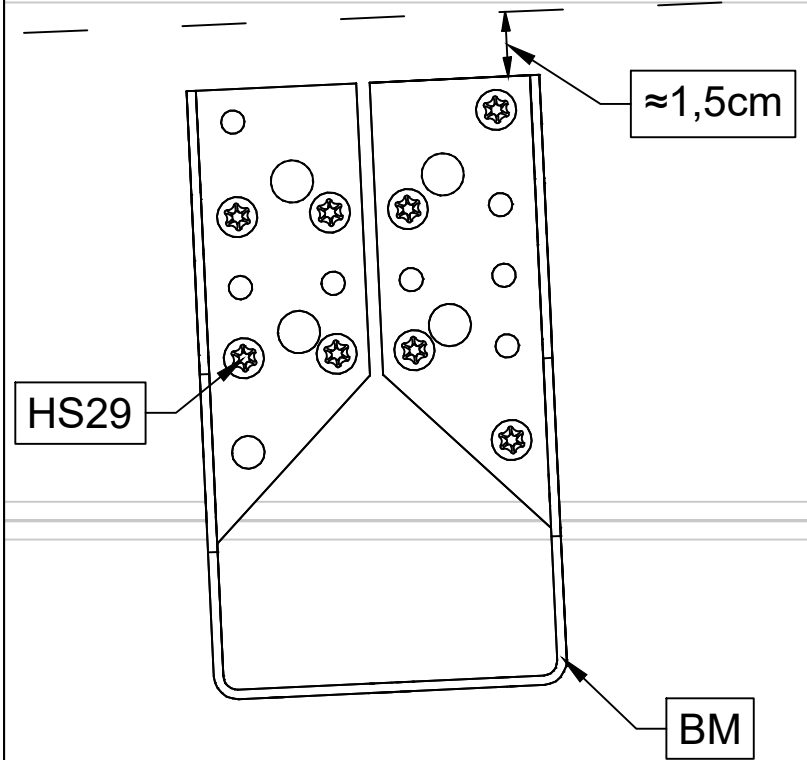

15

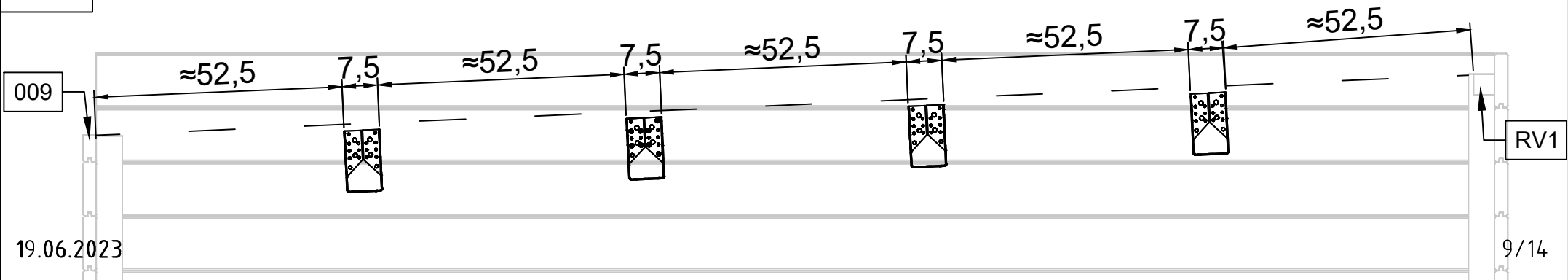

19.06.2023

9/14

Art. Nr. 2857101

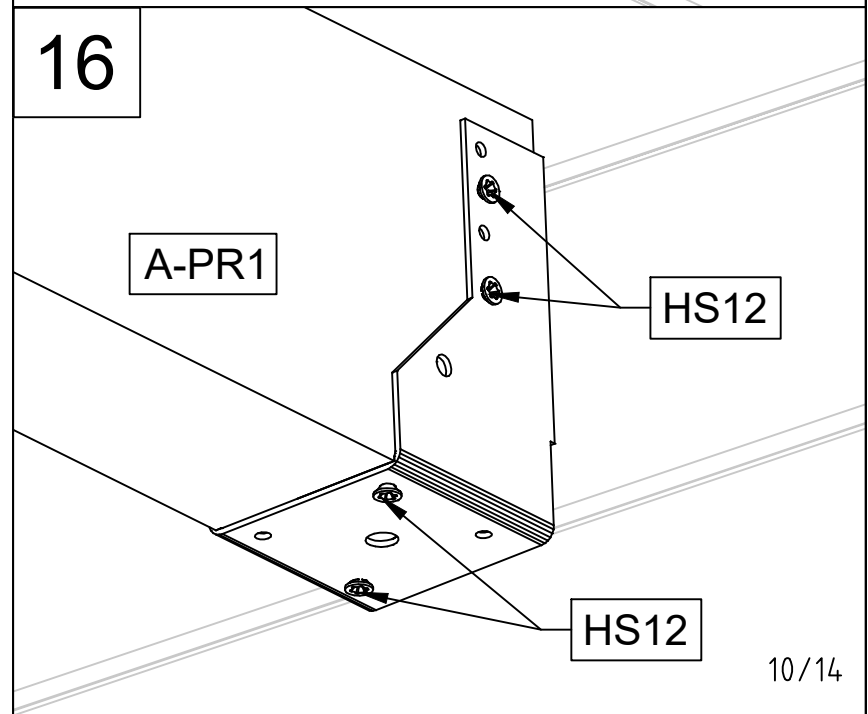
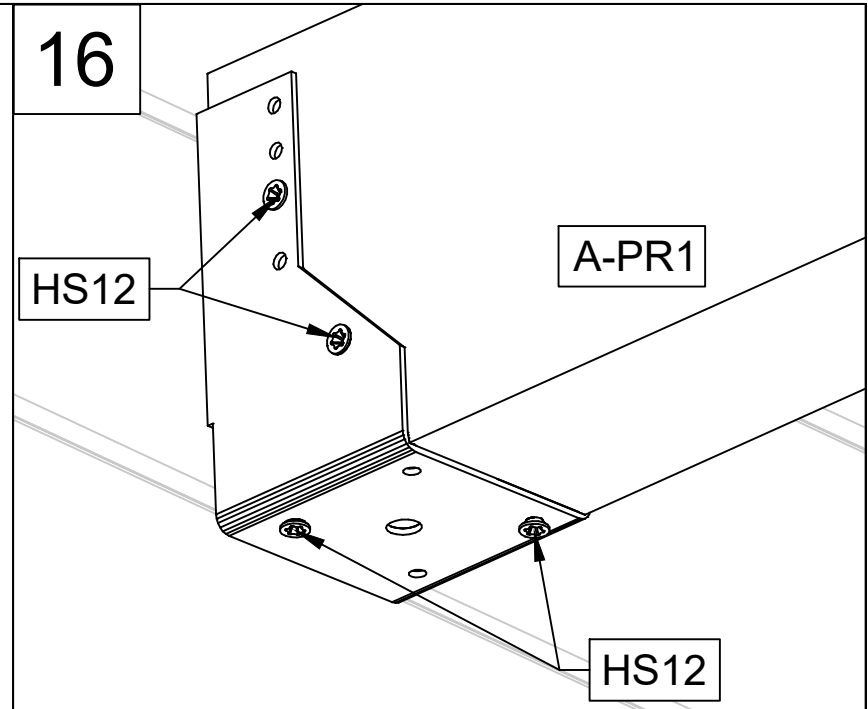

Art. Nr. 2857101

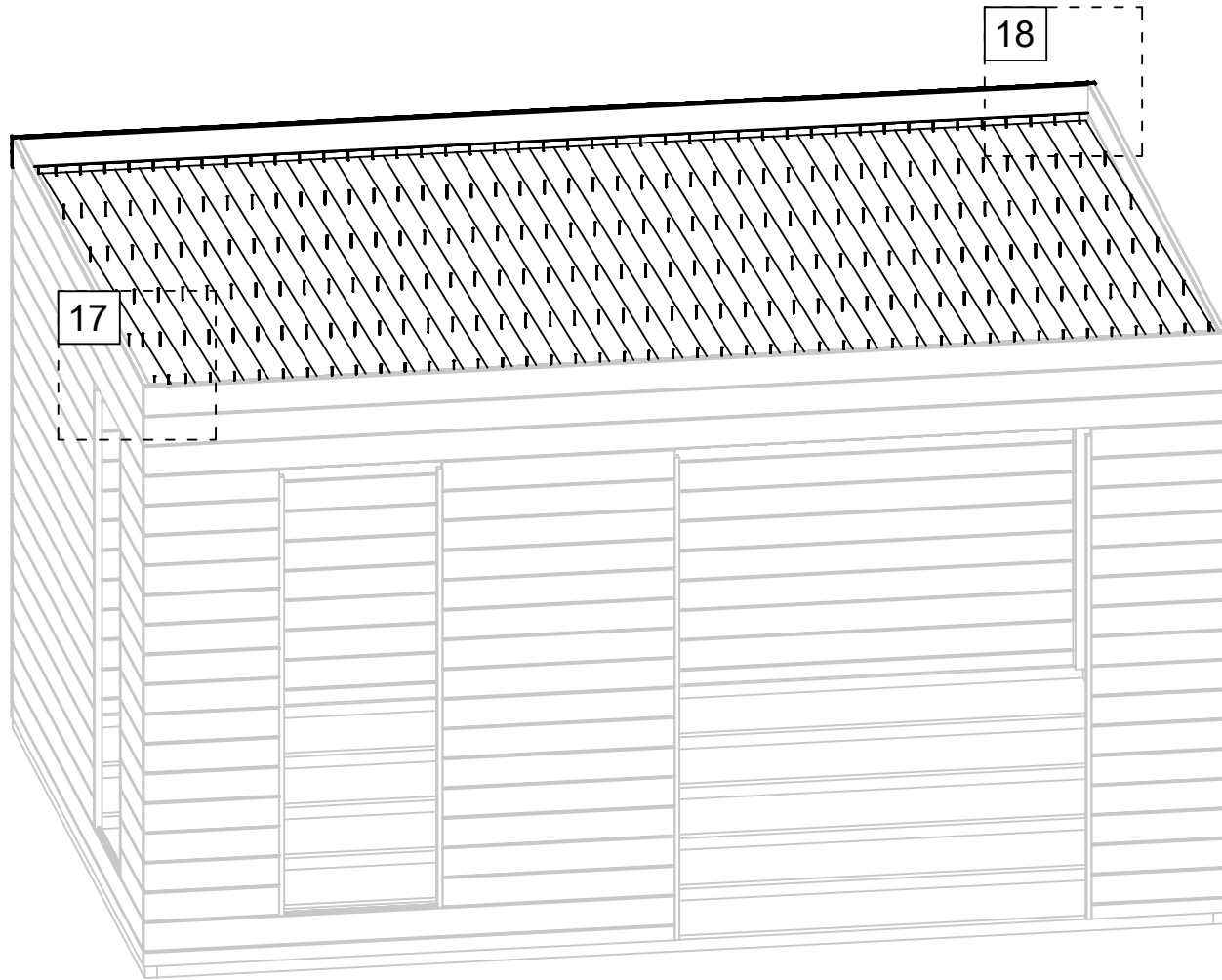

17

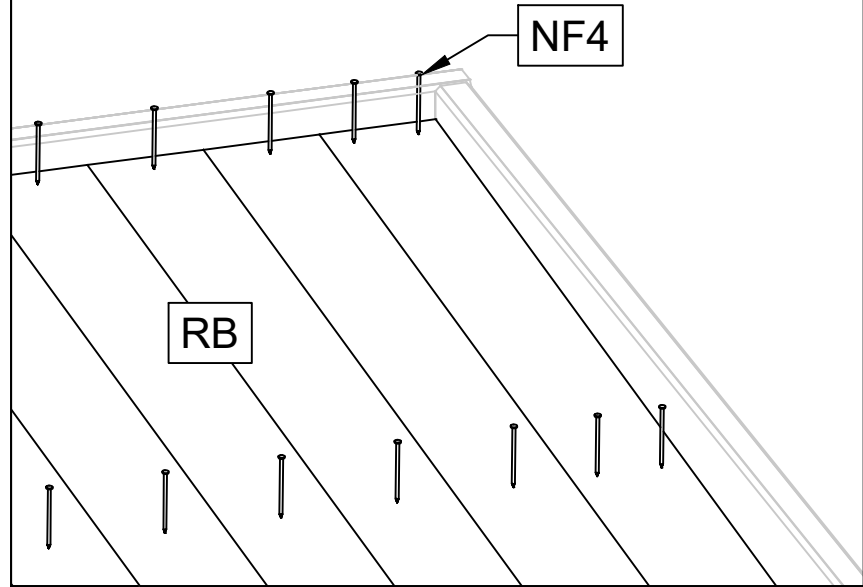

18

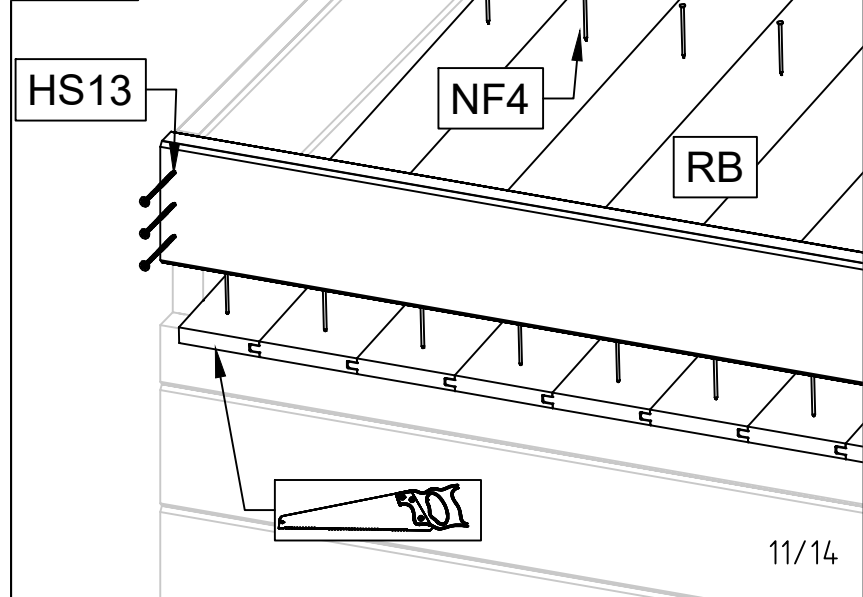

Art. Nr. 2857101

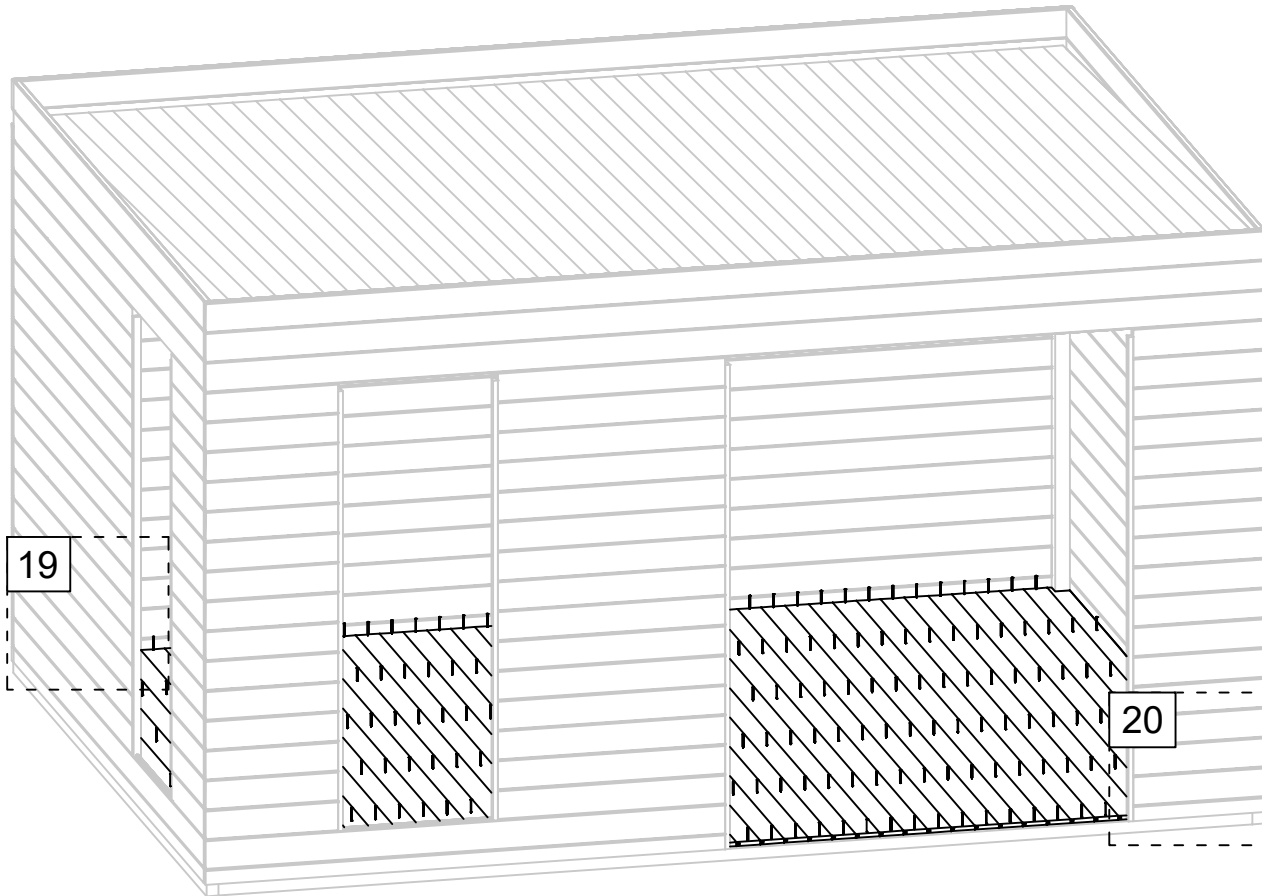

19

20

19.06.2023

19

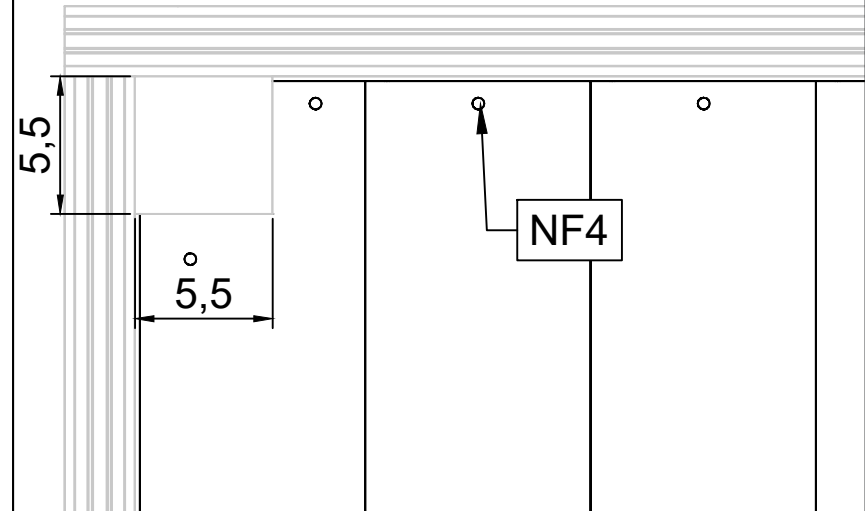
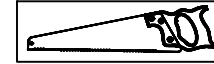

20

NF4

NF4

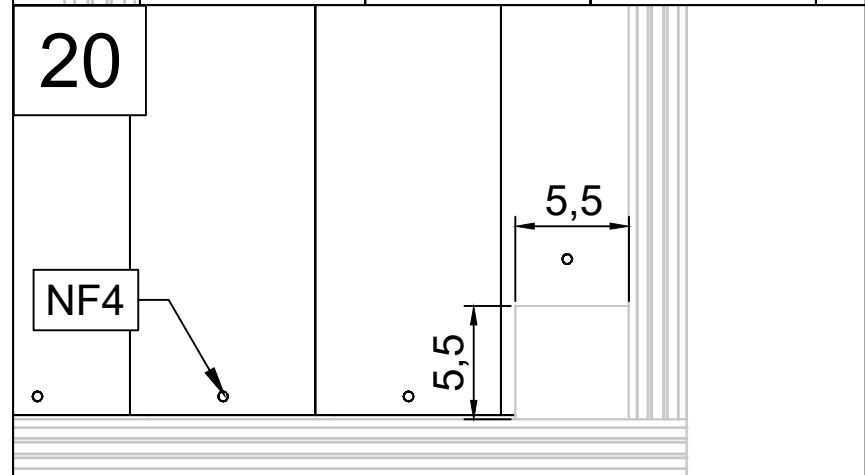

5,5

5,5

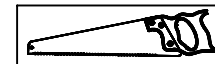

12/14

Art. Nr. 2857101

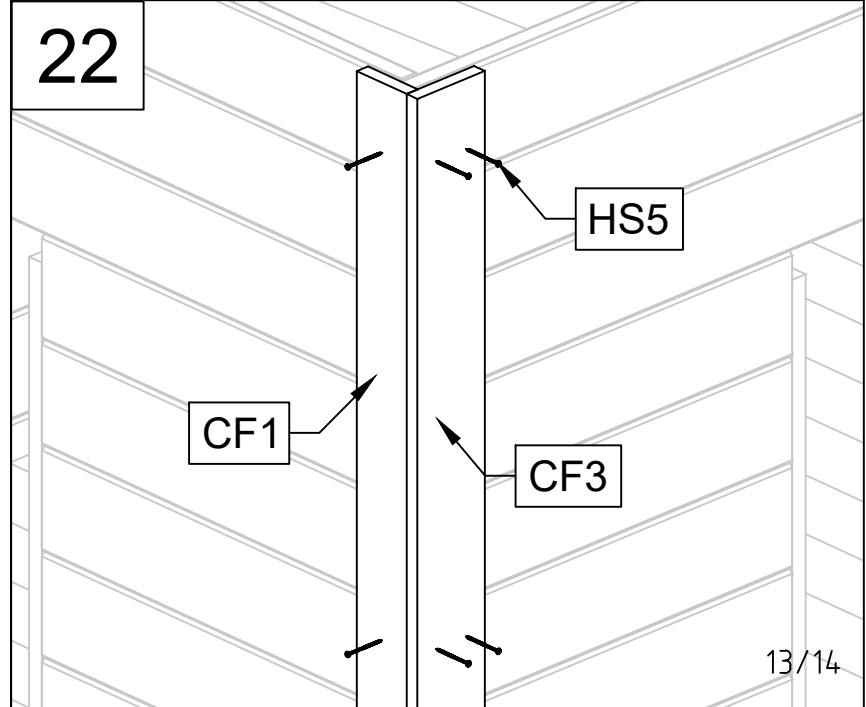
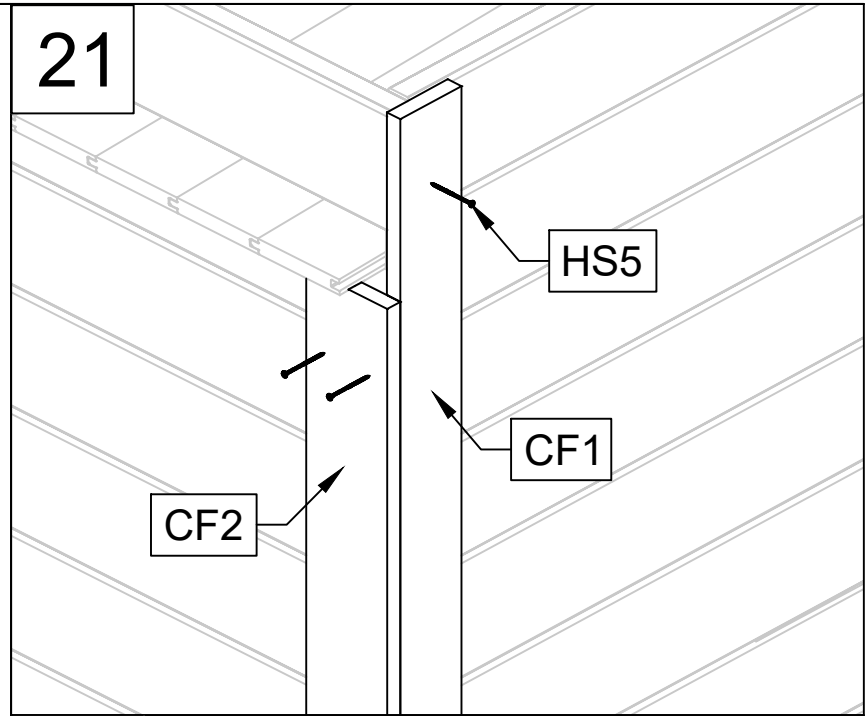
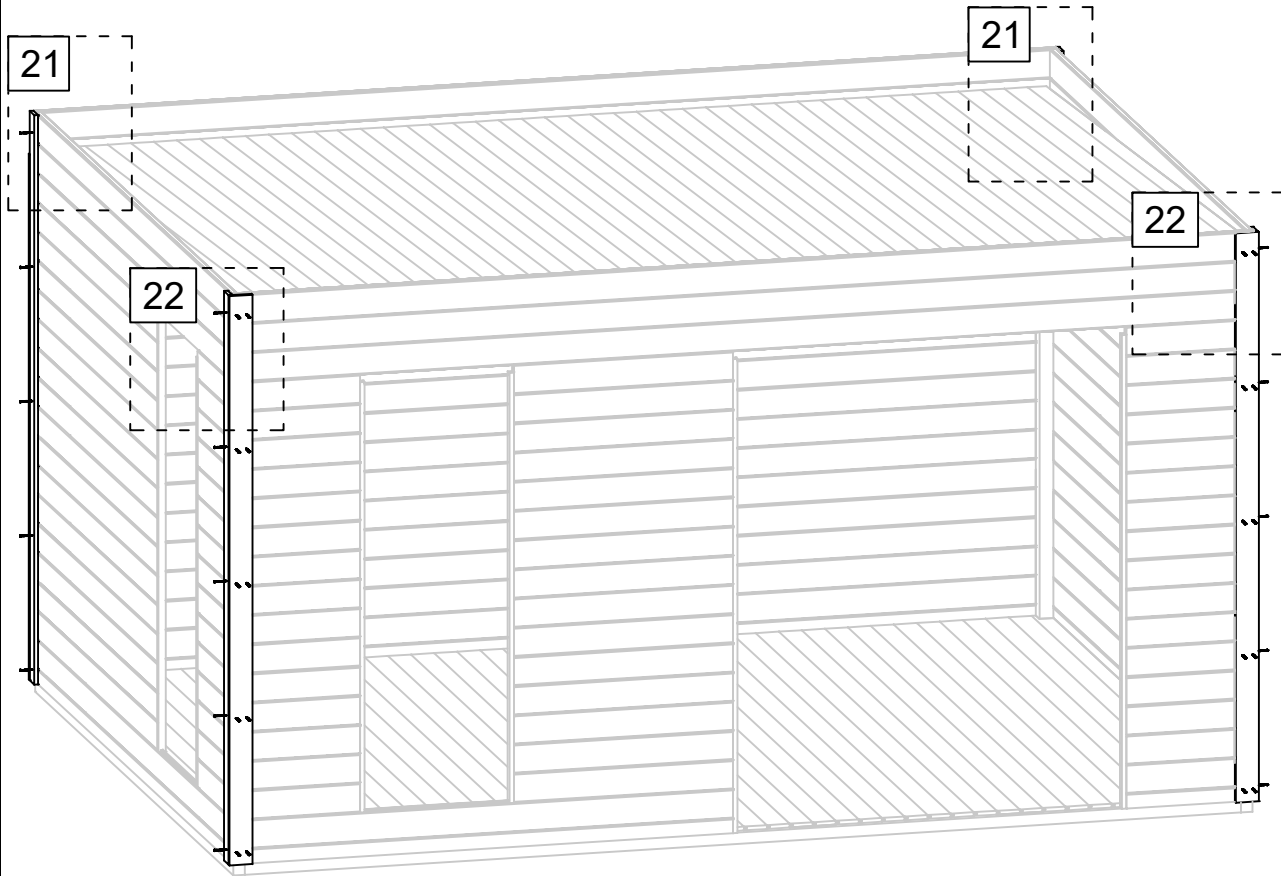

Art. Nr. 2857101

