

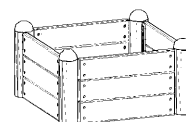

PLUS A/S  
Ådalen 13B  
DK-6600 Vejen  
phone: +45 7996 3333  
web: www.plus.dk

**PIPE6  
PIPE6A  
PIPE6L**



**PIPE8  
PIPE8A  
PIPE8L**

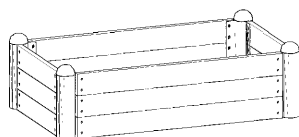

**PIPE16  
PIPE16A  
PIPE16L**

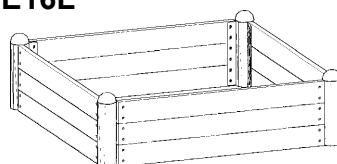

**PIPE17  
PIPE17A  
PIPE17L**

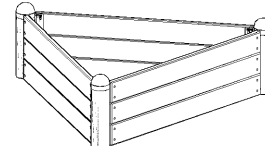

**PIPE10  
PIPE10A  
PIPE10L**

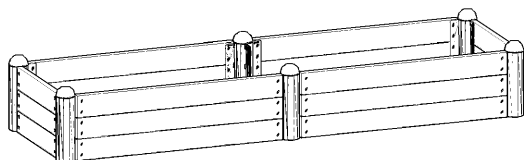

**PIPE19  
PIPE19A  
PIPE19L**

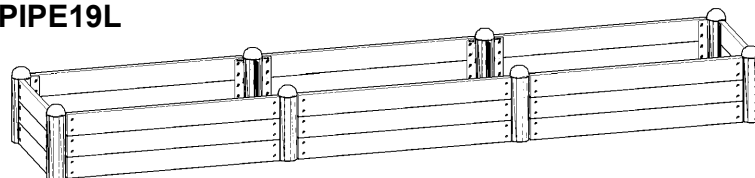

*Vi anbefaler at bruge opvaskemiddel for nemmere at kunne samle rør og gummi bøsning.*

*We recommend using dishwashing detergent to more easily assemble pipes and rubber bushings.*

*Wir empfehlen die Verwendung von Spülmittel, um die Rohr- und Gummibuchsen leichter zu montieren.*

**PIPE6C**

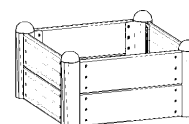

**PIPE8C**

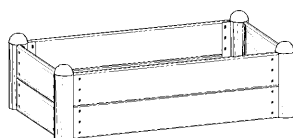

**PIPE16C**

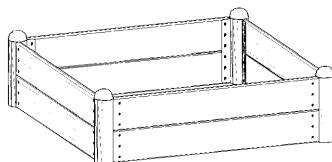

**PIPE17C**

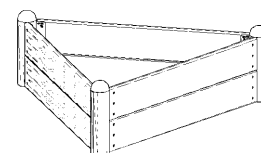

**PIPE10C**

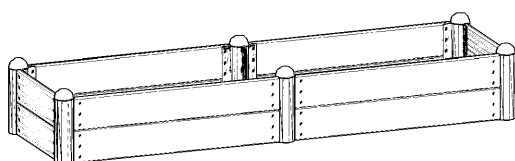

**PIPE19C**

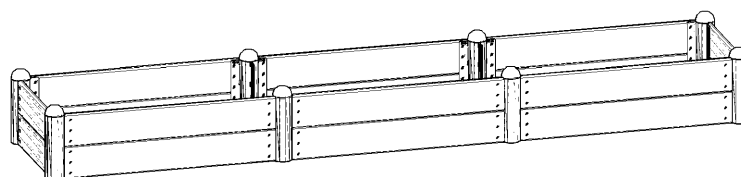

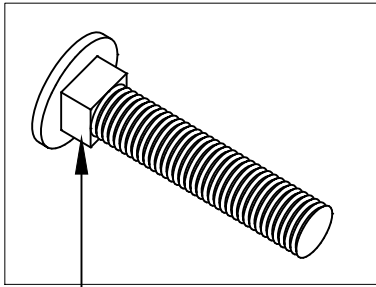
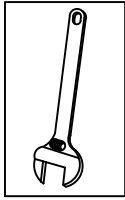
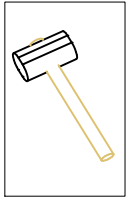

TRÆ  
WOOD  
HOLZ

Det firkantede stykke er med til at låse bolten.

The square piece helps to lock the bolt.

Das quadratische Stück hilft, den Bolzen zu verriegeln.

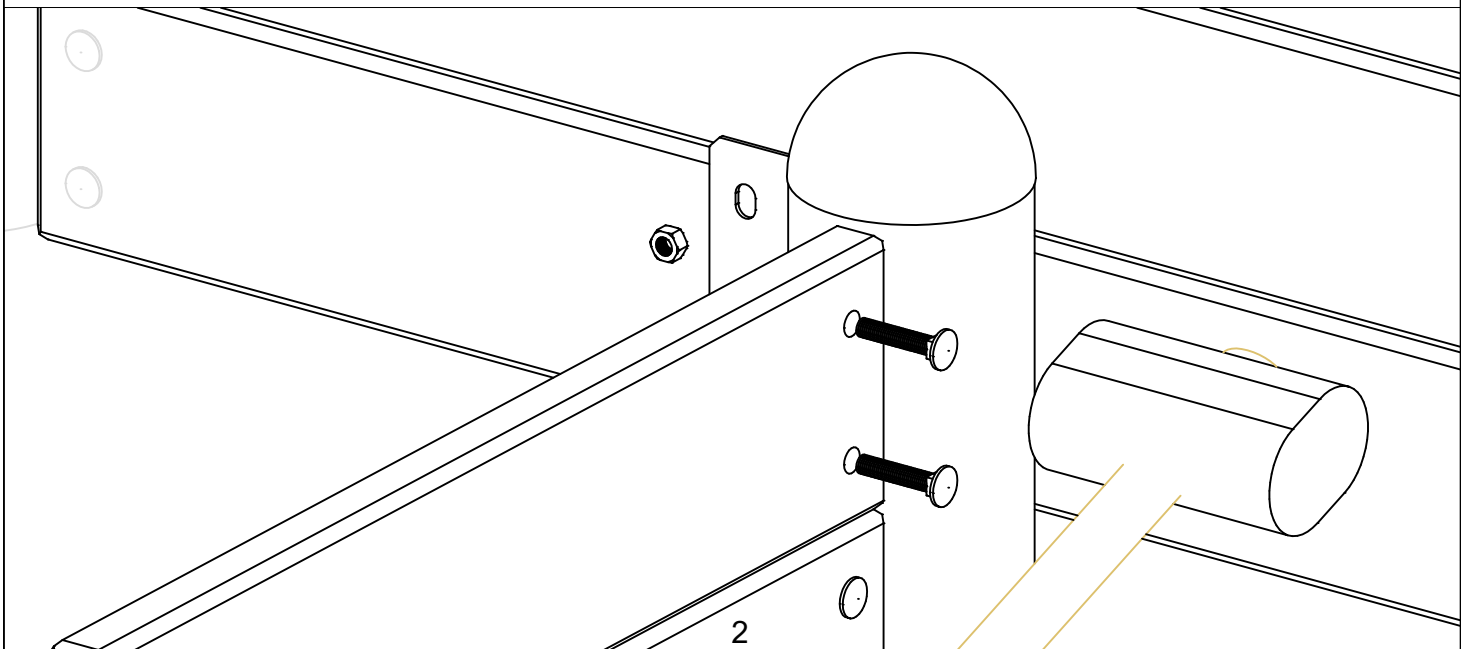
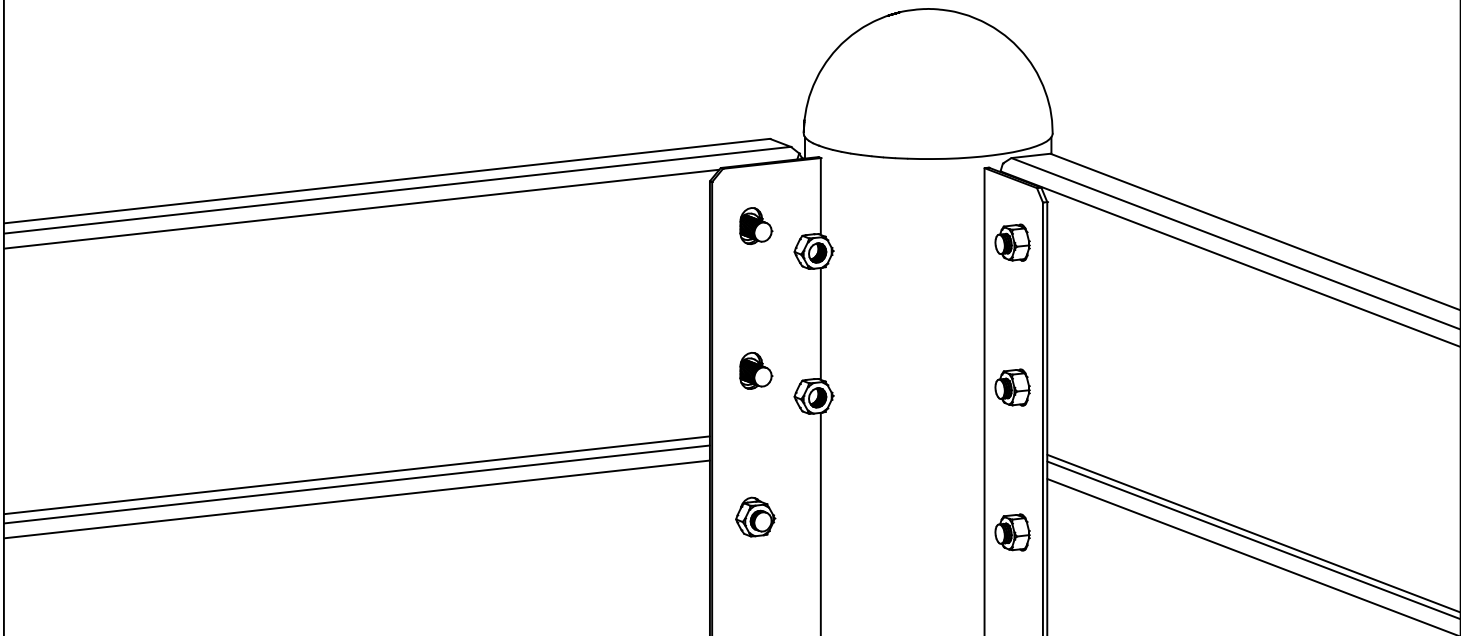

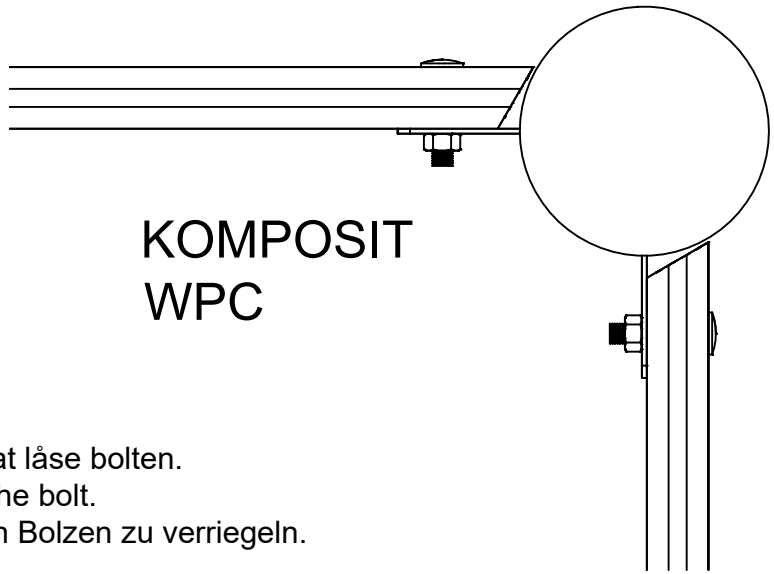
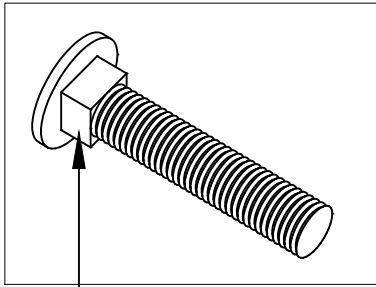
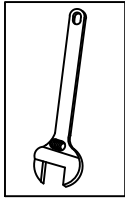
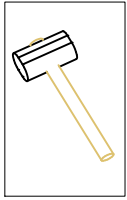

## KOMPOSIT WPC

Det firkantede stykke er med til at låse bolten.  
The square piece helps to lock the bolt.  
Das quadratische Stück hilft, den Bolzen zu verriegeln.

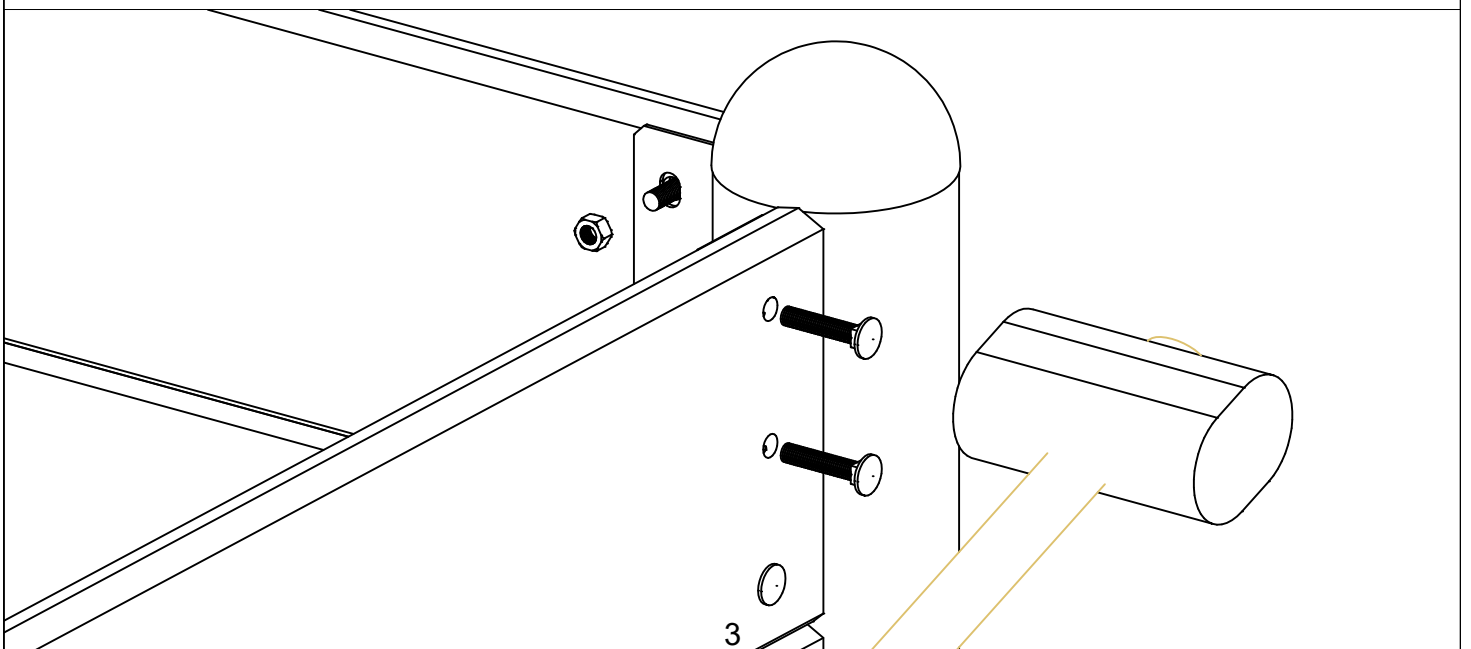
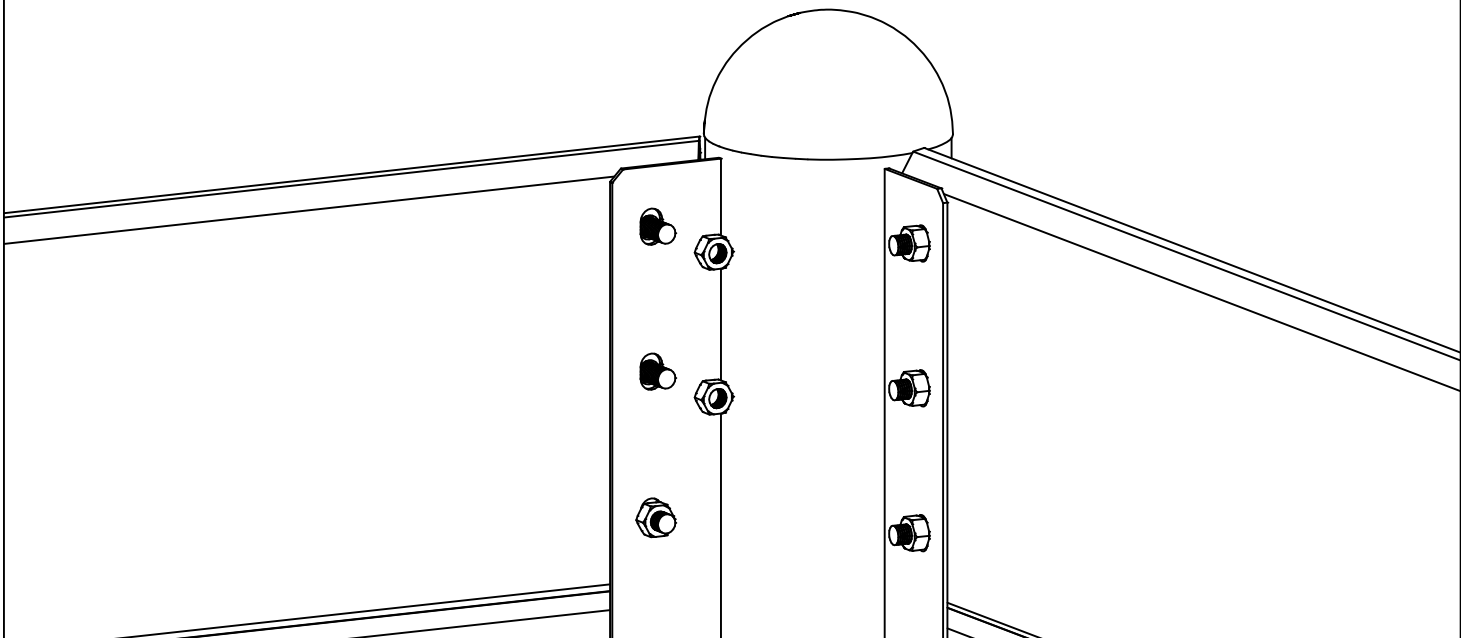

# 17820

PIPE10  
PIPE10A  
PIPE10L

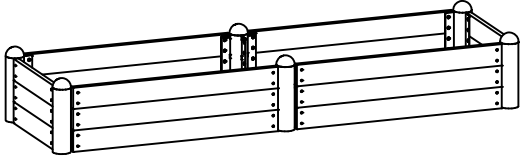

PIPE19  
PIPE19A  
PIPE19L

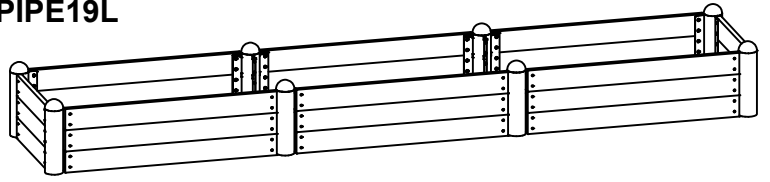

PIPE10C

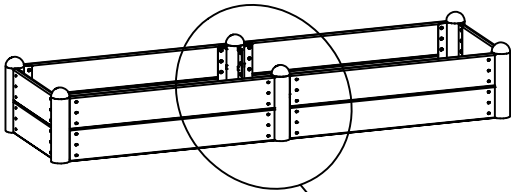

PIPE19C

