

GS 25S4 800X525

The standard competitive HPT (2.500 kg)



GS 25

The GS hand pallet truck represents an easy to use, economic and robust tool for transporting pallet loads.

Reliable and easy to maintain, this model has been designed to be an excellent solution for intense use.

GS is the right machine for the customer that is looking for a simple and sturdy pallet truck: the right companion for every day work that can adapt in every situation.



HYDRAULIC UNIT

The GS pump has been designed with extreme care of details in order to have superior characteristics and features, such as:

- **Monolithic design:** the resistant and reliable one-piece cast iron housing protects all components avoiding any accidental damages. Pump housing is processed with CNC machines to achieve high precision tolerances and high accuracy.
- **Chromed piston rod and oil seal:** in order to avoid rust and prevent oil leakage during the use.
- **Maximum pressure valve:** safety device that protects the transpallet against overloads.
- ON/OFF lowering valve



STANDARD CONFIGURATION

- Nylon - Poly 45 steering wheels
- Nylon rollers
- Four curves handle with all the controls in a single lever and with large grasping areas on the side. This allows to have much comfort during the operations avoiding excessive fatigue and comfort during pushing loads.

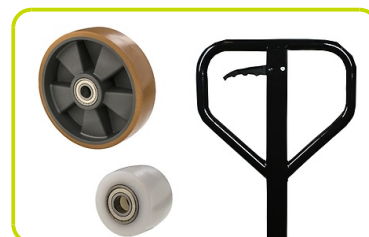

VARNISHING

Following an appropriate conditioning operation the frame is varnished with polyester powder at a temperature of 250° to guarantee maximum resistance to wear and atmospheric agents.



EASY TO MOUNT

Tiller easy to assemble with a fast mounting system. Robust tiller connection with two full welded joints that assure superior sturdiness in the toughest application.



OPTIONAL CONFIGURATION

- Aluminium - Rubber steering wheels



- Polyurethane rollers



- **Manual control brake.** The brake of the pallet truck, available with rubber steering wheels, is adjustable through the tiller lever to ensure safe use on slopes and ramps. The locking function makes it possible to park the pallet truck even on slopes without rolling away.



Description

1.1 Manufacturer			LIFTER
1.3 Drive			Manual
1.4 Operator type			Pedestrian
1.5 Load capacity	Q	Kg	2500
1.6 Load centre distance	c	mm	400
1.8 Load axle to end forks	x	mm	582
1.9 Wheel base	y	mm	842

Weights

2.1 Service weight		Kg	57
2.2 Axle load, laden rear		Kg	1978
2.2 Axle load, laden front		Kg	579
2.3 Axle load, unladen rear		Kg	18
2.3 Axle load, unladen front		Kg	39

Tyres/Chassis

3.1 Tyres: front wheels			NYLON/POLY
3.1 Tyres: rear wheels			NYLON
3.2 Tyre size: Steering wheels - Diameter		mm	200
3.2 Tyre size: Steering wheels - Width		mm	45
3.3 Tyre size: Load rollers - Diameter		mm	82
3.3 Tyre size: Load rollers - Width		mm	60
3.5 Tyre size: rear wheels - Q.ty (X=driven)		nr	4
3.6 Tread, front	b10	mm	155
3.7 Tread, rear	b11	mm	375

Dimensions

4.4 Lift height	h3	mm	115
4.9 Height of tiller in drive position max	h14	mm	1185
4.15 Height, lowered	h13	mm	85
4.19 Overall length	l1	mm	1200
4.20 Length to face of forks	l2	mm	400
4.21 Overall width	b1	mm	525
4.22 Fork dimensions - Thickness	s	mm	55
4.22 Fork dimensions - Width	e	mm	150
4.22 Fork dimensions - Length	l	mm	800
4.25 Distance between fork arms	b5	mm	525
4.32 Ground clearance, centre of wheelbase	m2	mm	30
4.34 Aisle width	Ast	mm	1673
4.35 Turning radius	Wa	mm	1017

Performance data

5.2 Lifting speed laden	strokes	12
5.2 Lifting speed unladen	strokes	12

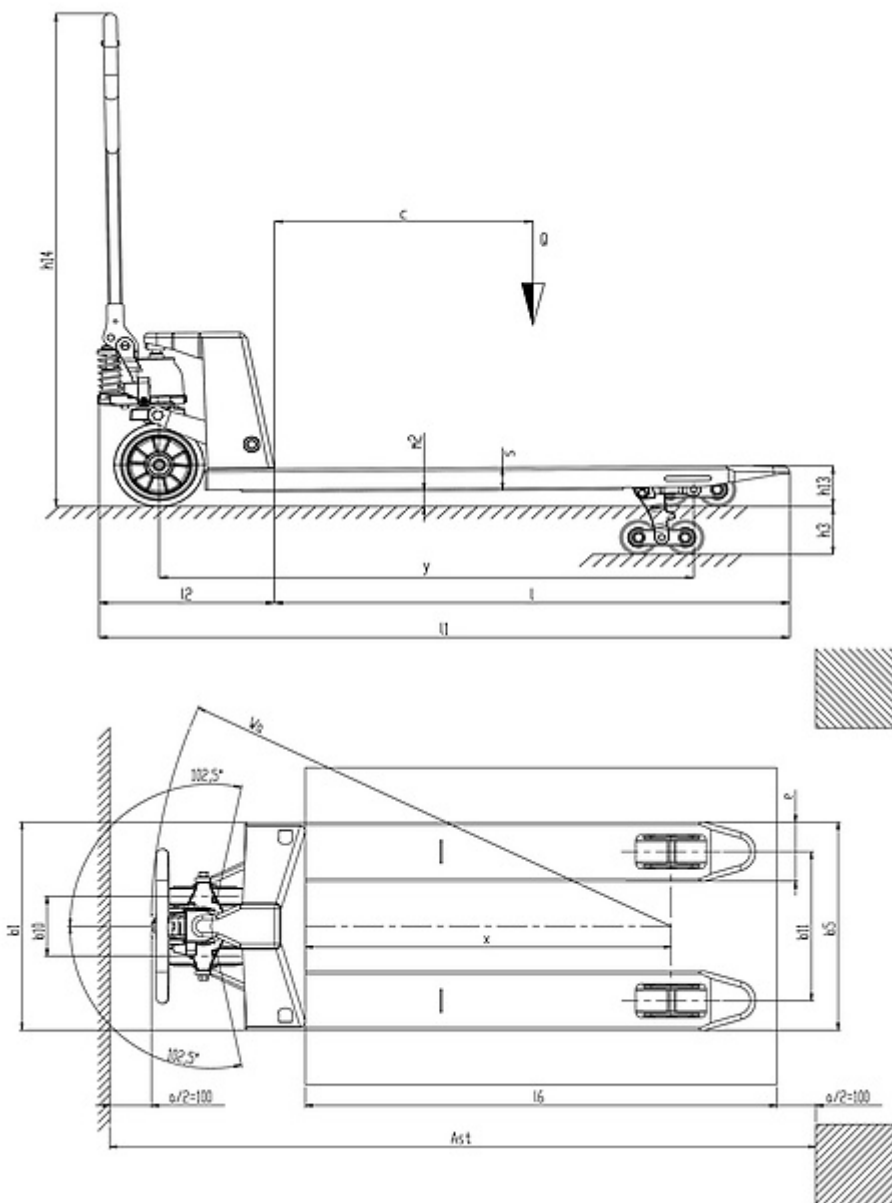

The information is aligned with the Data file at the time of download. Printed on 07/07/2021 (ID 12804)

©2021 | PR INDUSTRIAL s.r.l. | All rights reserved | Image shown may not reflect actual package. Specifications subject to change without notice

